

Schlaucharmaturen und Zubehör

Hose Fittings and Accessories

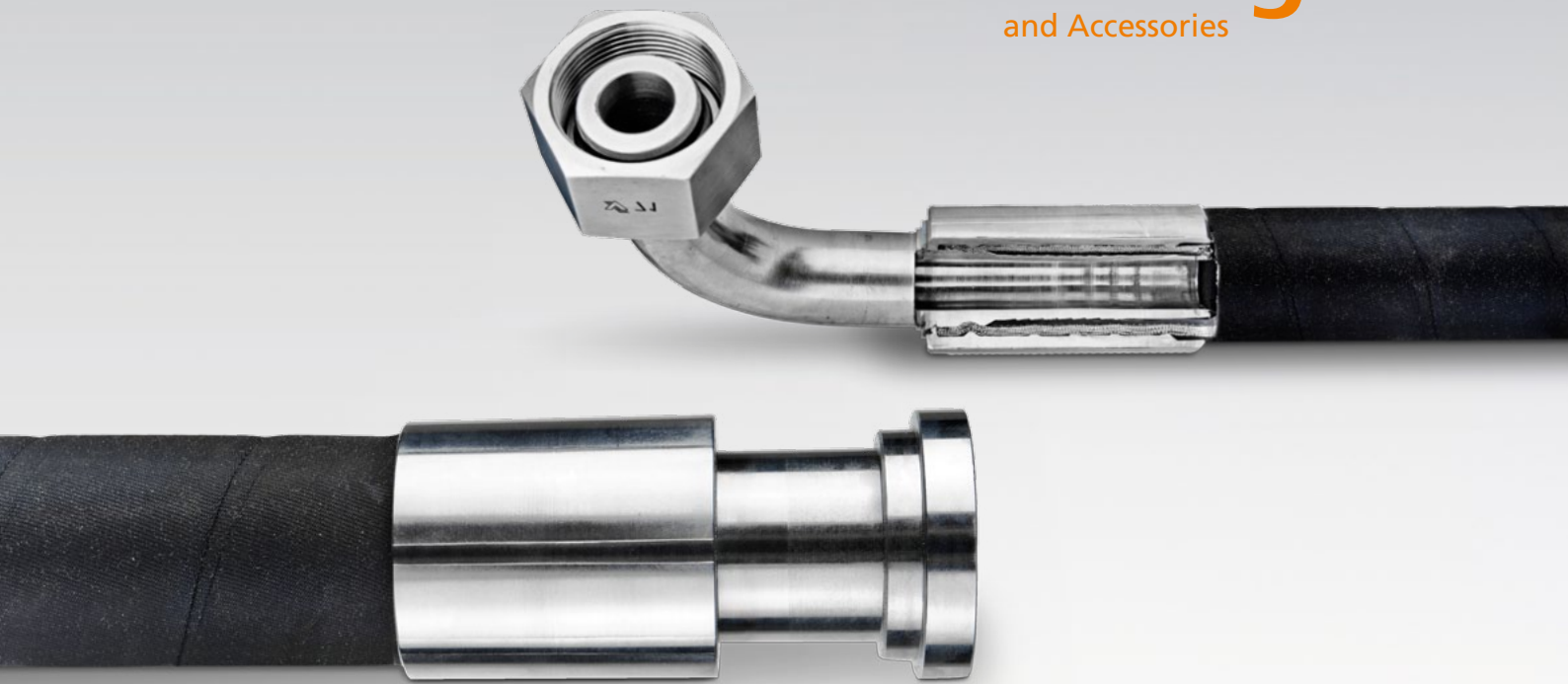

Damit Verbindungen gelingen!
Make better connections!

4

Schlaucharmaturen

und Zubehör

Hose Fittings

and Accessories



Vertrauen Sie auf Volz – damit Verbindungen gelingen

**Rely on Volz –
for better connections**

Vertrauen Sie auf Rohrverbindungen „Made in Germany“ – Stahl und Edelstahl

Es gibt nur eine Handvoll Hersteller von Rohrverschraubungen, Schlauchverbindungen und Adaptern für hydraulische Anlagen. Sie sind alle Spezialisten. Wir auch. Allerdings ist Volz nicht nur Spezialist für Stahl oder Edelstahl – sondern für beides. Die Volz Gruppe liefert unter den wenigen deutschen Unternehmen, die Rohr- und Schlauchverbindungskomponenten sowohl in Stahl als auch in Edelstahl anbieten, das breiteste Programm aus eigener Fertigung.

Welche Vorteile das für Sie hat? Wir beraten Sie in beiden Produktbereichen und wägen gemeinsam mit Ihnen sorgfältig ab, welches Produkt aus unserem umfangreichen Programm das optimale für Ihre Anwendung ist. Sie wiederum können sich auf die Sicherheit unserer Verbindungen in beiden Materialien voll und ganz verlassen.

Denn bei uns findet der gesamte Zerspanungs- und Fertigungsprozess im eigenen Haus statt. Und kann flexibel und schnell auf Ihre Bedürfnisse zugeschnitten werden, so dass wir Ihnen kurzfristig die Lösung für Ihre Aufgabe liefern. Egal, ob diese im Edelstahl- oder im Stahlbereich liegt.

Außer all den absolut zuverlässigen Rohr- und Schlauchverbindungen für hydraulische Anlagen, die Sie in unserem neu und übersichtlich gegliederten Katalog finden, bekommen Sie bei uns auch Produkte, die noch keine Serien- und Bestellnummern haben – aber Ihr ganz individuelles Problem lösen.

Volz – Ihre flexibelste Quelle für sichere Verbindungen in Stahl und Edelstahl



Volz ist Ihre sicherste Quelle
Volz is your safest source

Volz ist Ihre flexibelste Quelle
Volz is your most flexible source

Volz ist die deutsche Quelle für Stahl und Edelstahl
Volz is the German source for carbon steel and stainless steel

You can trust Volz steel and stainless steel tube couplings "Made in Germany"

There are only a handful of specialist manufacturers who produce tube and hose couplings and adapters for hydraulic plants. We are one of them. However, Volz are not just specialists for steel or stainless steel fittings – we specialise in both. Under the very few German companies who supply both steel and stainless steel tube and hose coupling components, the Volz Group offer the widest program from our own production.

What advantage does this have for you? We consult with you about both product ranges and together we can come to decision about which product from our wide range is best suited to your particular application. You can then have full trust in our couplings made from either material.

By Volz the entire metal working manufacturing process is completed in our own workshops. This process can be rapidly and flexibly tailored to your requirements, so that we can quickly supply a solution for your commission, no matter whether this is in steel or stainless steel.

Apart from all the absolutely reliable tube and hose connectors for hydraulic systems that you will find in our new and clearly laid out catalogue, we can also supply you with non-standard products that have no order number – but would solve your own individual problem.

Volz – your flexible source for safe steel and stainless steel couplings.

Zu Ihrer Sicherheit!

Verbindungselemente sind teilweise extremen Belastungen wie z. B. Schwingungen, unkontrollierten Druckspitzen etc. ausgesetzt.

Nur die Verwendung von Volz Komponenten sowie die Einhaltung unserer Montageanleitungen garantieren die Produktsicherheit, sowie die Einhaltung der geltenden Normen.

Das Nichtbeachten dieser Regeln kann die Funktionssicherheit der Produkte erheblich beeinträchtigen, Verletzungen verursachen, sowie Eigentum beschädigen.

Dies führt zum zwingenden Verlust unserer Gewährleistung! In jedem Fall gilt unsere Gewährleistung nur für Volz Produkte. Alle Angaben ohne Gewähr.

Alle Schlauchmontagen müssen nach erfolgter Montage auf Ihre Funktionssicherheit hin geprüft werden.

Technische Änderungen vorbehalten.

For your safety!

Under certain conditions components may be subjected to extreme loads such as vibration and uncontrolled pressure peaks.

For your own safety and the safety of others we recommend only using genuine Volz components and Volz approved methods of assembly.

Warranty is limited to Volz products and wholly dependent upon compliance with Volz approved methods of assembly. Failure to follow the Volz assembly procedures may compromise the integrity of a system and could result in personal injury or property damage.

All hose assemblies should be proof tested as part of the assembly procedure.

Every endeavour has been made to ensure the information provided is correct and complete at the time of going to print. Errors and omissions are not intentional. Please contact the Volz technical department to enquire about any alterations or additions to the information contained within. All information is presented in approximate values. Tolerances are contained within the relevant standards or form part of the technical section of each component or procedure.

Subject to technical alteration.



Bestellen bei Volz – Ihre Vorteile:

Schlauchnippel, Fassungen und Adapter sowie 24°-DIN-Rohrverschraubungen und 37°-JIC-Verschraubungen

- Zertifikate wie DNV, Lloyds, TÜV usw. vorhanden
- Großes Portfolio ab Lager verfügbar
- Sonderteile kurzfristig lieferbar durch eigene Produktion „Made in Germany“
- 3.1-Zeugnis – 100 Prozent Rückverfolgbarkeit
- 1.4571-(316Ti) – Edelstahl höchster Qualität für beste Performance

The advantages of ordering from Volz:

Hosetails, ferrules and adapters, as well as 24° DIN cutting ring couplings and 37° flared tube (JIC) couplings

- Certified by DNV, Lloyd's, TÜV and others
- Large portfolio available from stock
- Special parts deliverable at short notice, thanks to in-house production „Made in Germany“
- 3.1-documentation – 100% traceability
- 1.4571-(316Ti) stainless steel – top quality for optimum performance



Wir sind gern für Sie da

For you, we are always available

T +49 7426 939-550

F +49 7426 939-555

www.volz.de | sales@volz.de



Zertifikate Certificates



■ Qualität lässt sich messen. Die Zertifikate namhafter Prüfinstitute beweisen, dass Sie mit Volz-Produkten auf der sicheren Seite sind.

■ Quality can be measured. Certificates from reputable testing institutes prove that you are safe with Volz products.

- Det Norske Veritas
- Germanischer Lloyd
- Lloyd's Register
- DVGW
- ABS
- RMRS
- TÜV
- GOST-R

www.volz.de

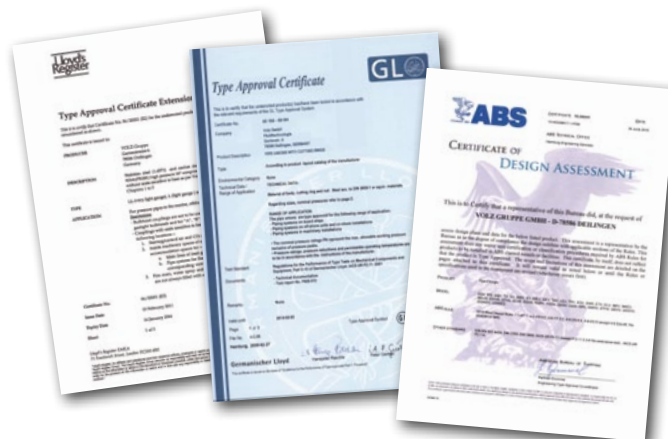

Technische Informationen Technical Information	14 - 37
Schlaucharmaturen Hose Fittings	38 - 71
Schlaucharmaturen - Interlock Hose Fittings - Interlock	72 - 85
Pressfassungen Ferrules	86 - 102
Index Index	103

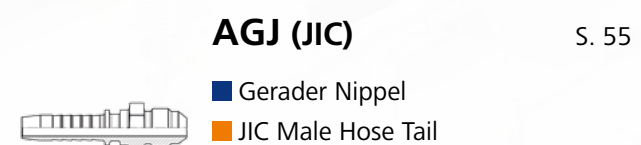
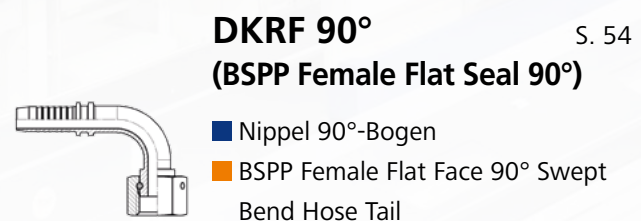
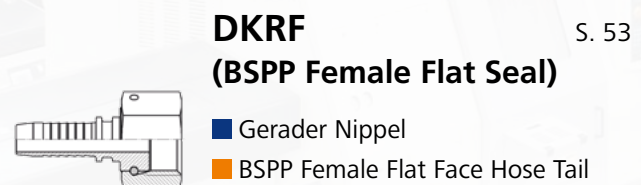
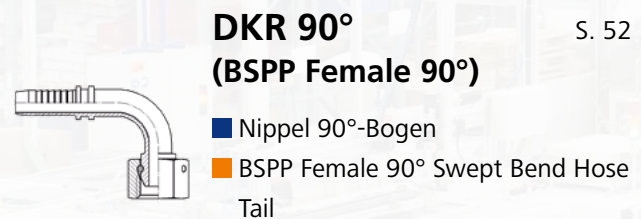
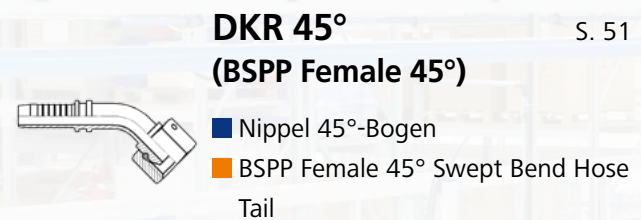
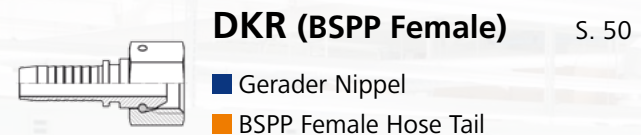
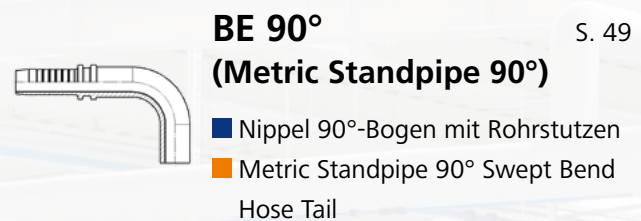
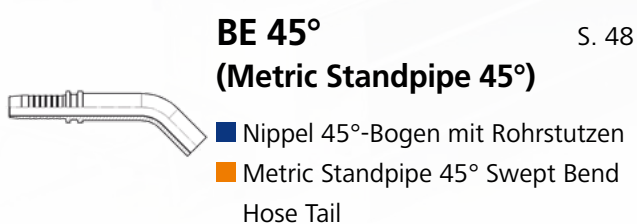
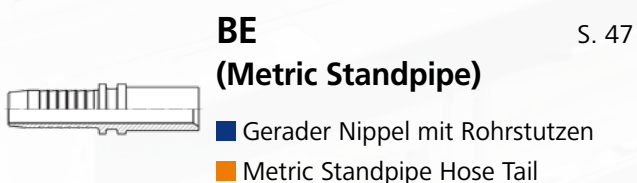
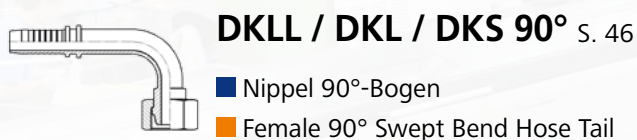
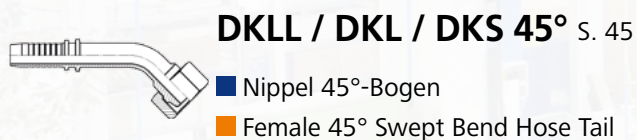
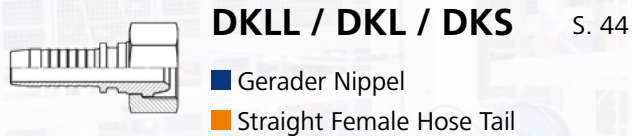
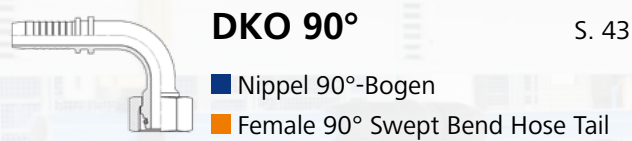
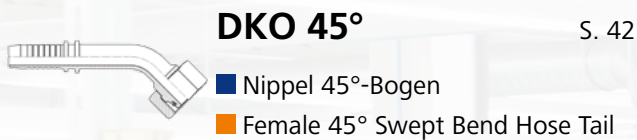
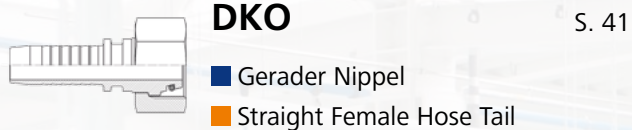

Schlaucharmaturen **Hose Fittings**



DKJ (JIC Female) S. 56

- Gerader Nippel
- JIC Female Hose Tail

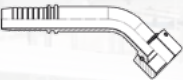

DKJ 45° (JIC Female 45°) S. 57

- Nippel 45°-Bogen
- JIC Female 45° Swept Bend Hose Tail

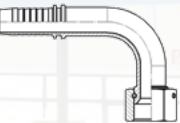

DKJ 90° (JIC Female 90°) S. 58

- Nippel 90°-Bogen
- JIC Female 90° Swept Bend Hose Tail



CE (Metric Male) S. 59

- Gerader Nippel
- Metric Male L/S Hose Tail



AGR (BSPP) S. 60

- Gerader Nippel
- BSPP Male Hose Tail



AGR WD (BSPP WD) S. 61

- Gerader Nippel
- BSPP Male WD Hose Tail



AGR BSPT-m (BSPT Male) S. 62

- Gerader Nippel
- BSPT Male Hose Tail



AGN (NPT) S. 63

- Gerader Nippel
- NPT Male Hose Tail



DSN (Hose Connector) S. 64

- Gerader Doppelnippel
- Hose Tail Joiner



SFL3 / SFS6 (Code 61 / 62) S. 65

- Gerader Nippel
- Code 61/62 Flange Hose Tail



SFL3 / SFS6 45° (Code 61 / 62 45°) S. 66

- Nippel 45°-Bogen
- Code 61/62 Flange 45° Swept Bend Hose Tail

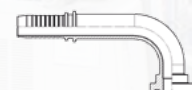

SFL3 / SFS6 90° (Code 61 / 62 90°) S. 67

- Nippel 90°-Bogen
- Code 61/62 Flange 90° Swept Bend Hose Tail



RGN (Banjo Hosetail) S. 68

- Ringnippel
- Banjo Hose Tail



HSCH (Banjo Bolt) S. 69

- Hohlschraube
- Banjo Bolt



DKO KÄ (Water Blaster) S. 70

- Gerader Waschgeräte-Nippel
- Water Blaster Female Hose Tail

Schlaucharmaturen Interlock Hose Fittings Interlock

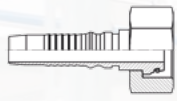
DKO - IN S. 74
(DKO Interlock)

- Gerader Nippel mit Ausreißsicherung
- Straight Female Interlock Hose Tail

DKO 45° - IN S. 75
(DKO Interlock 45°)

- Nippel 45°-Bogen mit Ausreißsicherung
- Female 45° Swept Bend Interlock Hose Tail

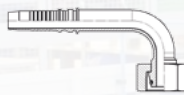
DKO 90° - IN S. 76
(DKO Interlock 90°)

- Nippel 90°-Bogen mit Ausreißsicherung
- Female 90° Swept Bend Interlock Hose Tail

DKR - IN S. 77
(BSPP Female Interlock)

- Gerader Nippel mit Ausreißsicherung
- BSPP Female Interlock Hose Tail

DKR 45° - IN S. 78
(BSPP Female Interlock 45°)

- Nippel 45°-Bogen mit Ausreißsicherung
- BSPP Female 45° Swept Bend Interlock Hose Tail

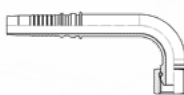
DKR 90° - IN S. 79
(BSPP Female Interlock 90°)

- Nippel 90°-Bogen mit Ausreißsicherung
- BSPP Female 90° Swept Bend Interlock Hose Tail

AGR - IN S. 80
(BSPP Interlock)

- Gerader Nippel mit Ausreißsicherung
- BSPP Male Interlock Hose Tail

AGR 45° - IN S. 81
(BSPP Interlock 45°)

- Nippel 45°-Bogen mit Ausreißsicherung
- BSPP 45° Male Interlock Hose Tail

AGR 90° - IN S. 82
(BSPP Interlock 90°)

- Nippel 90°-Bogen mit Ausreißsicherung
- BSPP 90° Male Interlock Hose Tail

SFL3 / SFS6 - IN S. 83
(Code 61 / 62 Interlock)

- Gerader Nippel mit Ausreißsicherung
- Code 61/62 Flange Interlock Hose Tail

SFL3 / SFS6 45° - IN S. 84
(Code 61 / 62 Interlock 45°)

- Nippel 45°-Bogen mit Ausreißsicherung
- Code 61/62 Flange 45° Swept Bend Interlock Hose Tail

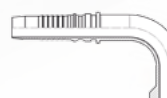
SFL3 / SFS6 90° - IN S. 85
(Code 61 / 62 Interlock 90°)

- Nippel 90°-Bogen mit Ausreißsicherung
- Code 61/62 Flange 90° Swept Bend Interlock Hose Tail

Pressfassungen **Ferrules****2 TE - EN 854**

S. 88

1 Fabric Braid Hose
no skive**3 TE - EN 854**

S. 89

2 Fabric Braid Hose
no skive**1 ST - EN 853 - SAE
100 R1A**

S. 90

1 Wire Skive Hose
skive1**2 ST - EN 853 - SAE
100 R2A**

S. 91

2 Wire Skive Hose
skive1**1 SN - EN 853 - SAE
100 R1AT**

S. 92

1 Wire Non Skive Hose
no skive**2 SN - EN 853 - SAE
100 R2AT**

S. 93

2 Wire Non Skive Hose
no skive**1 SC - EN 857 - ISO
11237-1 1SC**

S. 94

1 Wire Compact Non Skive Hose
no skive**2 SC - EN 853 - SAE
100 R17/R19**

S. 95

2 Wire Compact Non Skive Hose
no skive**R 7 - EN 855 - SAE R7**

S. 96

R7 Thermoplast Hose
no skive**T1 Teflonschlauch**

S. 97

Smooth Bore PTFE Hose
no skive**W1 Teflon-
Wellschlauch**

S. 98

Convolutated PTFE Hose
no skive**4 SP - EN 856 - SAE
100 R9R**

S. 99

4SP Multispiral Hose
skive1**4 SH - EN 856**

S. 100

4SH Multispiral Hose
skive2**R 13 - EN 856 - SAE
100 R13**

S. 101

R13 Multispiral Hose
skive2**SAE 100 R15**

S. 102

R15 Multispiral Hose
skive2

Technische Informationen

Technical Information



Inhalt

Allgemeines	S.16
Funktionsbeschreibung der Rohrverschraubung	S.16
Anwendungskriterien	S.19
Normung, Druckbereiche	S.20
Temperaturen, Druckabschläge	S.21
Einschraubzapfen, Einschraublöcher für Rohrverschraubungen	S.22
Metrische Gewindeanschlüsse	S.24
Rohranschlussmaße für Stutzen	S.25
Volumenstrom	S.26
Nomogramm	S.27
Längentoleranz bei montierten Schlauchleitungen	S.28
Messbeispiele für Schlauchleitungen, Verdrehwinkel	S.30
Grundregeln für das Verlegen von Schlauchleitungen	S.31
Druckverlust in Schlauchleitungen	S.32
Umrechnungstabelle, Dichtungswerkstoffe	S.33
Volz ZnNi-Beschichtung	S.34

Index

General information	S.16
Description of function of screwed pipe connections	S.16
Criteria for use	S.19
Standards, pressures	S.20
Temperatures, pressure reductions	S.21
Stud ends and ports for tube couplings	S.22
Thread type information	S.24
24° cutting ring cone end for tube couplings	S.25
Flow volume	S.26
Hose chart	S.27
Hose dimensions – General information	S.28
Measuring examples for hose connections	S.30
Basic rules for fitting hose connections	S.31
Pressure drop chart	S.32
Conversion table, sealing materials	S.33
Volz ZnNi coating	S.34



Allgemeines

Volz-Rohrverschraubungen und Komponenten aus nicht-rostendem Stahl (Werkstoff 1.4571) finden aufgrund des breitgefächerten Produktionsprogramms in vielen Bereichen der Fluidtechnik Anwendung. Das Programm wird ständig erweitert und den neuesten technischen Bedürfnissen und Entwicklungen angepaßt. Durch das Baukastenprinzip können Probleme im Bereich Verbindung und Adaptierung mit Rohren sicher und leicht gelöst werden.

Alle Baureihen sind komplett verfügbar und mit hoher Präzision gefertigt. Komponenten und Sonderteile (letztere nach Absprache der technischen Details) können kurzfristig geliefert werden. Im Hinblick auf Funktionssicherheit wird einwandfreie Montage und spannungsfreier Einbau der Rohrverlegung vorausgesetzt. Die Zulassungsbedingungen internationaler Klassifikationsgesellschaften sind bzgl. unserer Produkte erfüllt.

Funktionsbeschreibung der Rohrverschraubungen

Ausgangsbasis sind die Verschraubungen nach DIN 2353, ISO 8434 mit Bohrungsform W, DIN 3861 (24° Konus) und deren Stutzen als Standardbauelemente. Funktionelle und dichte Verbindungen zwischen Stutzen und Rohr stellen grundsätzlich nachfolgende Verschraubungsarten dar, wobei die Auswahl den technischen Bedürfnissen angepaßt werden sollte. Bei gleichen Stutzen ist eine Auswechselbarkeit unserer verschiedenen Systeme rohranschlußseitig möglich.

General information

Volz pipe connections and components of rustproof steel (material 1.4571) are universally used in fluid technology due to Volz's widely varied production program. This program is being continuously expanded and adapted to the latest technical requirements and developments. Its modular construction principle provides simple, reliable solutions to problems related to the connection and adaptation of pipes.

All product lines are kept completely on stock and manufactured with high precision. Components and custom parts (after specification of technical details) can be delivered on short-term notice. Proper assembly and stressfree installation of the pipework is a prerequisite for operating safety. Volz products fulfil the conditions for approval of international classification societies.

Description of function of screwed pipe connections

The screwed pipe connections are based on screwed connections according to DIN 2353, ISO 8434 with bore hole shape W, DIN 3861 (24° cone) and the corresponding connection pieces these elements are used as standard components. The screwed connection types described in the following all represent functional, tight connections between connection piece and pipe. The selection described must be adapted to the specific technical requirements. When the same connection pieces are used, the various Volz systems can be exchanged on the pipe connection side.

Zweikantenschneidring-Verschraubung

In den meisten Bedarfsfällen werden durch Verwendung des Zweikantenschneidringes Vorteile erzielt. Bei Anzug der Überwurfmutter greift zunächst die vordere Schneidkante in das Rohr ein und bei weiterem Anzug die zweite Schneidkante. Nach Beendigung der funktionellen Einschnitte der Schneidkanten ist, bedingt durch die konstruktive Formgebung des Schneidringes, eine weitere Eindringtiefe begrenzt. Gleichzeitig hat sich das Verkeilen des Ringes zwischen Rohr und Stutzen vollzogen. Sowohl in radialer als auch in axialer Richtung ist hierdurch Formschlüssigkeit erreicht worden.

Durch die Profilgebung und hohe Formschlüssigkeit werden auftretende Kräfte auf der gesamten Konuslänge günstig verteilt. Hierdurch wird eine optimale Schwingungssicherheit, hohe Sicherheit gegen Biegewechselspannungen sowie Druck- und Temperaturschwankungen erreicht.

Aufgrund der hohen Oberflächengüte sind relativ günstige Anziehdrehmomente erreichbar. Die Gefahr einer „Übermontage“ ist durch den spürbar starken Anstieg des Momentes (nach funktionsgerechtem Eingriff der Schneidkanten) deutlich erkennbar. Eine leichte „Übermontage“ beeinträchtigt die Gesamtfunktion nicht.

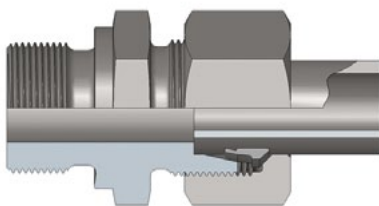

■ Vor dem Anzug der Überwurfmutter
 ■ Before the union nut is tightened

Double-edge cutting ring screw connection

The use of a double-edge cutting ring offers advantages for most requirements. When the union nut is tightened, first the front cutting edge and then the second edge cuts into the pipe when the union nut is tightened further. After the functional cuts of the cutting edges have been completed, cutting depth is limited by the cutting ring design.

At the same time, the ring has become wedged between the pipe and the connection piece. Positive locking of the components is attained in this case in both radial and axial directions.

Due to the profile shape and highly positive locking, forces applied to the connection are distributed over the entire length of the cone. This provides optimum protection against vibrations, alternating bending stress and fluctuations in pressure and temperature.

Due to the high surface quality, a relatively advantageous tightening moment can be attained. The risk of “over-tightening” is reduced due to the noticeably heightened increase of the tightening moment (after the cutting edges have properly cut into the pipe). Slightly “over-tightening” does not impair overall function.

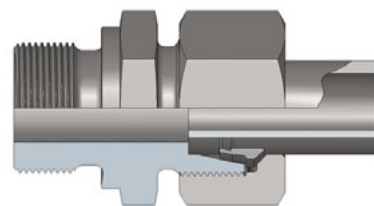

■ Nach dem Anzug der Überwurfmutter
 ■ After the union nut is tightened

Bördelverschraubung

Durch die Bördelverschraubung wird eine sichere Verbindung zwischen Stutzen mit Bohrungsform W, DIN 3861 und 37° gebördelten Rohrenden erreicht. Die Montage ist einfach und beliebig wiederholbar. Der Kegelring (mit eingelegten O-Ringen) wird bis zum spürbaren Anschlag in den Stutzen eingeführt. Durch seine Form sitzt er leicht klemmend im Stutzen fest. Bei Anzug der Überwurfmutter drückt der Druckring an die vorgeformte Bördelung des Rohres, die sich andererseits an den 37° Konus des Kegelringes anpreßt.

Durch die metallisch/elastomere Abdichtung ist eine denkbar sichere Funktion gewährleistet. Die komplette Verschraubung hält hohen Belastungen stand und sichert Biegemomenten und Schwingungen ab. Auch höhere Temperaturschwankungen beeinträchtigen die Funktion nicht. Es sind jedoch die zulässigen Höchsttemperaturen der verwendeten Dichtungswerkstoffe zu beachten. Dies gilt bei allen Verschraubungen mit elastomerer Abdichtung!

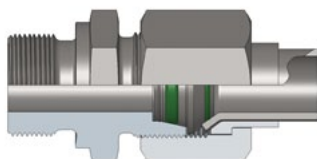

Flared tube fitting

The flared connection provides a secure connection between connection pieces with bore hole shape W, DIN 3861 and 37° flared pipe ends. Assembly is easy and can be repeated as often as required. The tapered ring (with inserted O-rings) is inserted into the connection piece until the stop is felt. Due to the shape of the tapered ring, it is lightly wedged into the connection piece. When the union nut is tightened, the thrust collar presses against the preformed flare of the pipe, which in turn presses against the 37° taper of the tapered ring.

Extremely reliable function is ensured by the metallic/elastomer seal. The entire screwed connection can withstand high loads and absorbs alternating bending moments and vibrations. Greater fluctuations in temperature do not influence function. The maximum permissible temperatures of the materials used must be taken into consideration. This applies to all screwed connections with elastomer seals.

Schweißkegelverschraubung

Die Rohrverschraubung mittels Schweißkegel stellt die sinnvolle Ergänzung zu den Schneidringverschraubungen dar. Es sind die gleichen Stutzen gemäß Bohrungsform W, DIN 3861 und entsprechende Überwurfmutter einsetzbar, so dass sich eine gleiche Bauhöhe ergibt. Eine sichere und dichte Verbindung zwischen Schweißkegel und Stutzen ist durch die metallische Abdichtung und zusätzlich eingesetzten O-Ring gegeben. Sie hält auch extremen Belastungen, insbesondere Druckstößen, Schwingungen und Temperaturschwankungen stand.

Achtung!

Die Verschweißung des Schweißkegels mit dem Rohr hat bedingt durch die Wärmeentwicklung vor der Einlage des O-Ringes zu erfolgen.

Welding cone screw connection

Screwed pipe connections employing welding cones is a logical supplement to the cutting ring screw connections. The same connection pieces with bore hole shape W, DIN 3861 and the corresponding union nuts are used, resulting in the same overall height. A reliable, tight connection between welding cone and connection piece is provided by the metallic seals and additional O-rings. Such connections withstand extreme loads, including pressure impacts, vibrations and fluctuations in temperature.

Attention!

Due to the high temperatures used, the welding cone must be welded to the pipe before the O-ring is inserted.

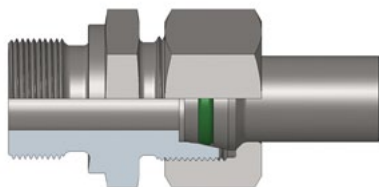

Dichtkegelverschraubung

Aufgrund des verwendeten Anschlusskegels (24°) ist eine normgerechte Verschraubung mit Stutzen (Bohrungsform W, nach DIN 3861) durchführbar. Durch den zusätzlich im Kegel eingelegten O-Ring kommt eine metallisch/elastomere Abdichtung zustande, die eine hohe Leckagesicherheit gewährleistet. Auch bei hohen Beanspruchungen besteht eine Unempfindlichkeit bei Druckstößen und Schwingungen. Die Baumaße entsprechen den Verschraubungen nach DIN 2353, ISO 8434. Rohranschlusseitig können wahlweise Schneidring-, Bördel- oder Schweißkegelanschlüsse montiert werden.

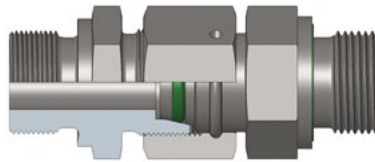

Tapered fittings /swivel connections

Due to the connecting cone (24°) used, a standardized screwed connection using connection pieces (bore hole shape W acc. to DIN 3861) is possible. The O-ring additionally inserted in the cone results in a metallic/elastomer seal which provides excellent protection against leakage. This connection is resistant to pressure impacts and vibrations even under high loads. The dimensions are identical to screwed connections according to DIN 2353, ISO 8434. Either cutting ring, flared or welding cone screw connections are possible for pipe connection.

Anwendungskriterien

Um die richtige Auswahl einer geeigneten Rohrverschraubung zu treffen, sollte der Anwender grundlegende Kriterien berücksichtigen. Vom gegebenen Sachverhalt ausgehend sind zielgerichtet Anforderung und Erwartung an das Verschraubungssystem zu knüpfen, wobei die max. zu erwartende Sicherheit Vorzug genießen sollte.

Insbesondere sind zu beachten die

- maximale Druckbelastbarkeit (unter Berücksichtigung temperaturbezogener Druckabschläge)
- Temperaturempfindlichkeit der Dichtungswerkstoffe (die Resistenz liegt z.B. bei FPM zwischen -25 bis +200 °C)
- Baumaße
- Lebensdauer, auch bei Wiederholmontagen
- Austauschmöglichkeit zwischen verschiedenen Rohrverschraubungsarten.

Criteria for use

In order to choose the best suited screwed pipe connection, a few basic criteria must be taken into consideration. Depending on the given circumstances, specific requirements and expectations must be defined which the screwed connection must fulfil. In the selection of screwed connection types, maximum possible safety should be given priority.

The following criteria must be given special attention:

- Max. resistance to pressure loads (in reference temperature dependent pressure reductions)
- Temperature sensitivity of material (the tolerance of, for example, FPM lies between -25 and +200 °C)
- Dimensions
- Service life, also in case of repeated assembly
- Option of exchanging screwed pipe connection types.

Normung

Das Standardprogramm der Volz-Rohrverschraubungen entspricht der DIN 2353, ISO 8434-1.

- Schneidringverschraubungen: Werden im Normalfall mit dem Zweikantenschneidring (PDR) geliefert.
- Rohranschlußseiten: DIN 3861 und DIN / ISO 8434-1
- Schweiß- und Dichtkegelverschraubungen: DIN 3865 / ISO 8434-1
- Bördelverschraubungen: SAE J 514 / ISO 8434-2 mit oder ohne zusätzlichen O-Ring am 37° - Konus des Kegelringes.
- Metrische- und Rohrgewinde: DIN 3852-1+2+11; ISO 1179-2+3; DIN ISO 6149-2+3
- NPT-Gewinde: ANSI/ASME B 1.20.1-1983
- UN/UNF-Gewinde: SAE J 514, ISO 11926-2+3
- Werkstoff der Bauteile gemäß DIN 3859: X6CrNiMoTi 17-12-2 (AISI 316 Ti) gem. DIN 17440 Werkstoff-Nr. 1.4571
- Dichtungsringe: FPM (z. B. Viton), PTFE (z. B. Teflon) und NBR auf Anfrage.
- Werkstoffabnahmeprüfzeugnis 3.1 nach DIN EN 10204 für Produkte aus 1.4571 auf Wunsch erhältlich. Bitte mit der Bestellung mitteilen.

Druckbereiche

Alle Druckangaben in bar nach DIN 2401. Temperaturen werden in °C angegeben. Bei der Druckbelastbarkeit unterscheidet man den Nenndruck PN vom Betriebsdruck PB. Unter Bezugnahme auf Sicherheit ist sie abhängig von der zulässigen Betriebstemperatur TB, die sich wiederum auf den Werkstoff und das Verschraubungssystem bezieht. Der Sicherheit wegen sind unbedingt die Druckabschläge zu berücksichtigen. Bei starken Druckspitzen oder hohen mechanischen Belastungen müssen Druckabschläge berücksichtigt werden.

Nenndruck PN

Der Nenndruck ist auf den Druck bezogen eine gebräuchliche und gerundete Kennzahl (siehe DIN 2401) und wird bei ruhender Belastung in nachstehender Tabelle mit mind. 4-facher Sicherheit angegeben.

Standards

Volz standard tube connection program complies with DIN 2353 and ISO ISO 8434-1

- 24° cone connectors – DIN 2353 / ISO 8434-1:
As standard supplied with double edge cutting ring (PDR).
- 24° tube connection cutting rings – DIN 3861 / ISO 8434-1
- 24° weld and swivel stud connectors – DIN 3865 / ISO 8434-1
- 37° flared tube connectors – SAE 514 / ISO 8434-2:
With or without O-ring seal on 37° taper
- Metric and BSP stud ends: DIN 3852-1+2+11; ISO 1179-2+3; DIN ISO 6149-2+3
- NPT stud ends – ANSI/ASME B 1.20.1-1983
- UN/UNF stud ends – SAE J 514; ISO 11926-2+3
- Component material acc. to DIN 3859: X6CrNiMoTi 17-12-2 (AISI 316 Ti) acc. to DIN 17440 material No. 1.4571
- Seals: FPM (e.g. Viton), on request PTFE (e.g. Teflon) and NBR.
- A material certificate 3.1 acc. to DIN EN 10204 for products made from 1.4571 is available on enquiry.
Please inform when ordering.

Pressures

All pressures are in bar in acc. with DIN 2401. Temperatures, where stated are in °C. Pressure ratings are divided into nominal pressure (PN) and working pressure (PB). In this context the information provided in the chapters "Temperatures" and "Pressure reductions" should be taken into account.

Nominal pressure PN

Nominal pressure is a common rounded value relating to static pressure (DIN 2401). Below table indicating 4-1 safety factor for relevant dimensions.

Baureihe Series	RAD O.D.	Nenndruck PN (Stahl) Nominal pressure (carbon steel)	Nenndruck PN (Edelstahl) Nominal pressure (stainless steel)
LL (sehr leicht) (very light-weight)	4 - 8	100	100
L (leicht) (light-weight)	6 - 10	500	500
	12 - 18	400	400
	22 - 42	250	250
S (schwer) (heavy duty)	6 - 10	800	800
	12 - 16	630	630
	20 - 38	420	420

Lediglich bei Rohraußendurchmessern von 30 mm und mehr (Baureihe „S“) und Drücken über 300 bar ist eine ca. 3-fache Sicherheit aufgeführt. Diese Angaben beziehen sich auf Schneidringverschraubungen. Gelten andere Nenndrücke sind diese im Katalog angegeben.

An approx. 3-fold safety reserve is specified only for pipes with outer diameters of at least 30 mm (product line „S“) and pressures of over 300 bar. These details apply to cutting ring couplings. If other nominal pressures apply, these are listed in the catalogue.

Betriebsdruck PB

Der zulässige Betriebsdruck für ein Bauteil ist der höchste Innenüberdruck, der für dieses Bauteil aufgrund des Werkstoffes und der Berechnungsgrundlagen bei der zulässigen Betriebstemperatur TB bei störungsfreiem Betrieb zulässig ist (DIN 2401). Bei ruhender Belastung ist die 2,5-fache bzw. 1,5-fache Sicherheit gegeben.

Operating pressure PB

The permissible operating pressure for a component is the maximum internal overpressure permissible for this component at the permissible operating temperature TB and proper operation (DIN 2401) based on material and design fundamentals. Safety factor x2.5 or x1.5 with static loads.

Bei zusammengesetzten Verschraubungen ist die Druckbegrenzung auf den niedrigsten Druck zu beziehen. Nenn- druck PN und Betriebsdruck PB sind bei normalen Betriebs- verhältnissen in etwa identisch.

For assembled screwed connections, the lowest pressure must be taken as the value for the pressure limit. Nominal pressure PN and operating pressure PB are roughly equivalent under normal operating conditions.

Jedoch sollten bei starken Druckstößen, höheren Temperaturen und mechanischen Schwingungen niedrigere Betriebsdrücke gewählt werden.

However, lower operating pressures should be set if extreme pressure impacts, high temperatures or mechanical vibrations occur.

Temperaturen

Volz-Verschraubungen werden aus nicht rostendem Stahl 1.4571 (316Ti) gemäß DIN 17440 hergestellt. Die zulässigen Betriebstemperaturen TB für dieses Material liegen zwischen -60 bis +400 °C (DIN 17440).

Temperatures

Volz hose fittings are manufactured from stainless steel 1.4571 (316Ti) acc. to DIN 17440. The operating temperature for this material is -60°C to +400 °C (DIN 17440).

Bei Dichtungswerkstoffen sind zu beachten:

- FPM (z. B. Viton®) -25 bis +200 °C
- PTFE (z. B. Teflon®) -60 bis +200 °C
- NBR (z. B. Perbunan®) -30°C to +100 °C

The seals used on Volz fittings have the following permissible operating temperatures.

- FPM (e.g. Viton®) -25°C to +200 °C
- PTFE (e.g. Teflon®) -60°C to +200 °C
- NBR (e.g. Perbunan®) -30°C to +100 °C

Es handelt sich hierbei um Richtwerte, die mehr oder weniger auch noch vom Medium beeinflusst werden können. Im Zweifelsfall oder bei Verwendung verschiedener Werkstoffe innerhalb einer Verschraubung sind die jeweils kleinsten Temperaturgrenzen anzusetzen.

Where Volz stainless steel hose fittings are used together with elastomer seals the lowest temperature indicated for each material is applicable.

Druckabschläge

Bei erhöhten Temperaturen sind Druckabschläge – in nachstehender Tabelle bezogen auf Werkstoff 1.4571 – anzusetzen.

Pressure reductions

However, pressure reductions should be made for Volz fittings where high operating temperatures are expected. The following table shows the pressure reductions to be made for stainless steel 1.4571 (316Ti)

Betriebstemperatur Temperature	-60 bis to +20°C	+50 °C	+100 °C	+200 °C	+300 °C	+400 °C
Druckabschläge in % Pressure reduction in %	-	4,5	11	20	29	33

Einschraubzapfen/Einschraublöcher für Rohrverschraubungen

Stud ends and ports for tube couplings

Einschraubzapfen Form B Stud end form B

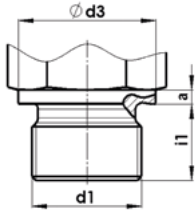

- Abdichtung durch Dichtkante
- Metal to metal sealing
- DIN 3852-1+2, ISO 1179-4

Einschraubzapfen Form E Stud end form E

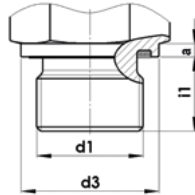

- Abdichtung durch Weichdichtung (WD)
- Elastomer seal (WD)
- DIN 3852-11, ISO 1179-2

B/E Metrisch Metric			
d1	Ød3	i1	a
M8x1	12	8	1,5
M10x1	14	8	1,5
M12x1,5	17	12	2
M14x1,5	19	12	2
M16x1,5	21	12	2
M18x1,5	23	12	2,5
M20x1,5	25	14	2,5
M22x1,5	27	14	3
M24x1,5	29	14	3
M26x1,5	31	16	3
M27x2	32	16	3
M30x2	36	16	3
M33x2	39	18	3
M36x2	42	18	3
M39x2	46	20	3
M42x2	49	20	3
M48x2	55	22	3

X Metrisch Metric				
d1	d4	a1	b1	t1
M8x1	13	1	8	10
M10x1	15	1	8	10
M12x1,5	18	1,5	12	15
M14x1,5	20	1,5	12	15
M16x1,5	23	1,5	12	15
M18x1,5	25	2	12	15
M20x1,5	27	2	14	17
M22x1,5	28	2,5	14	17
M24x1,5	30	2,5	14	17
M26x1,5	33	2,5	16	19
M27x2	33	2,5	16	20
M30x2	37	2,5	16	20
M33x2	41	2,5	18	22
M36x2	43	2,5	18	22
M39x2	47	2,5	20	24
M42x2	51	2,5	20	24
M48x2	56	2,5	22	26

Einschraubloch Form X Port form X

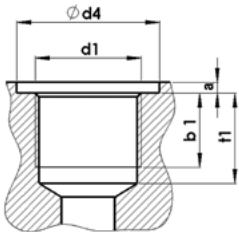

- für zylindrische Einschraubgewinde
- for parallel stud thread
- DIN 3852 T2, ISO 1179-1

B BSPP BSPP			
d1	Ød3	i1	a
G1/8-A	14	8	1,5
G1/4-A	18	12	2
G3/8-A	22	12	2,5
G1/2-A	26	14	3
G3/4-A	32	16	3
G1-A	39	18	3
G1.1/4-A	49	20	3
G1.1/42-A	55	22	3

X BSPP BSPP				
d1	d4	a1	b1	t1
G1/8	15	1	8	10
G1/4	20	1,5	12	15
G3/8	23	2	12	15
G1/2	28	2,5	14	18
G3/4	33	2,5	16	20
G1	41	2,5	18	23
G1.1/4	51	2,5	20	25
G1.1/2	56	2,5	22	27

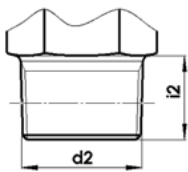

Einschraubzapfen Form C Stud end form C

- Abdichtung durch Kegelschleife
- Taper thread
- DIN 3852-1+2

C BSPT BSPT	
d2	i2
R1/8	8
R1/4	12
R3/8	12
R1/2	14
R3/4	14
R1	14
R1.1/4	15
R1.1/2	15

Z BSPT BSPT		
d1	b2	t3
Rp 1/8	5,5	8,5
Rp 1/4	8,5	12,5
Rp 3/8	8,5	12,5
Rp 1/2	10,5	16,5
Rp 3/4	13	19
Rp 1	11,5	16,5
Rp 1.1/4	11,5	16,5
Rp 1.1/2	11,5	16,5

C Metrisch Metric	
d2	i2
M8x1	8
M10x1	8
M12x1,5	12
M14x1,5	12
M16x1,5	12
M18x1,5	12
M20x1,5	14
M22x1,5	14
M24x1,5	14
M26x1,5	14
M27x1,5	14
M30x2	14
M33x2	14
M36x2	15
M39x2	15
M42x2	15
M48x2	15

Z Metrisch Metric		
d1	b2	t3
M8x1 4H5H	5,5	10
M10x1 4H5H	5,5	10
M12x1,5 4H5H	8,5	13,5
M14x1,5 4H5H	8,5	13,5
M16x1,5 4H5H	8,5	13,5
M18x1,5 4H5H	8,5	13,5
M20x1,5 4H5H	10,5	15,5
M22x1,5 4H5H	10,5	15,5
M24x1,5 4H5H	10,5	15,5
M26x1,5 4H5H	9,5	12
M27x2 4H5H	10,5	18
M30x2 4H5H	10,5	13,5
M33x2 4H5H	10,5	13,5
M36x2 4H5H	11,5	14,5
M39x2 4H5H	11,5	14,5
M42x2 4H5H	11,5	14,5
M48x2 4H5H	11,5	14,5

Einschraubloch Form Z Port form Z

- für zylindrische und kegelige Einschraubgewinde
- for taper and parallel stud thread
- DIN 3852 T2, ISO 1179-1

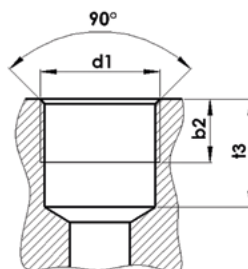

Einschraubzapfen/Einschraublöcher für Rohrverschraubungen

Stud ends and ports for tube couplings

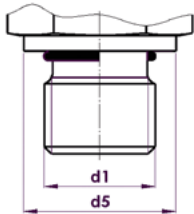

Einschraubzapfen Form F

Stud end form F

- mit O-Ring Dichtung
 - with O-Ring sealing
- (DIN 3852 T3) + (SAE J 514)

Einschraubloch Form W

Port form W

- für O-Ring Dichtung
 - with O-Ring-sealing
- (DIN 3852 T3, ISO 6149) + (SAE J 514)

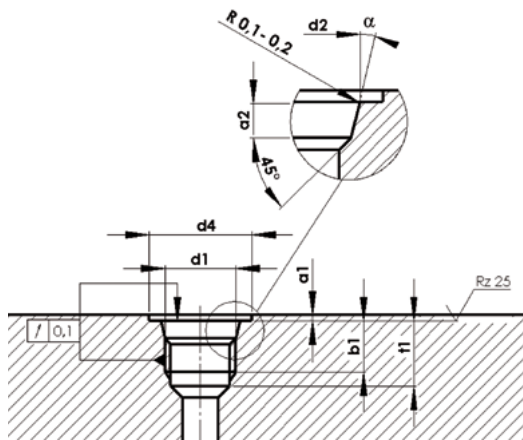

Metrisches ISO-Gewinde (= DIN 3852 bzw. ISO 6149) Metric ISO-thread (= DIN 3852 bzw. ISO 6149)

d1	d5	d4 _{min}	d3	d2 _{+0,1}	a1 _{max}	a2	t1 _{min}	b1 _{min}	± α 1°
M 8 x 1	10,9	17	11	9,1	1,0	1,6	11,5	10,0	12°
M 10 x 1	12,9	20	13	11,1	1,0	1,6	11,5	10,0	12°
M 12 x 1,5	16,9	22	16	13,8	1,5	2,4	14,0	11,5	15°
M 14 x 1,5	18,9	25	18	15,8	1,5	2,4	14,0	11,5	15°
M 16 x 1,5	20,9	27	20	17,8	1,5	2,4	15,5	13,0	15°
M18 x 1,5	22,9	29	22	19,8	2,0	2,4	16,5	14,5	15°
M 20 x 1,5	24,9	32	24	21,8	2,0	2,4	16,5	14,0	15°
M 22 x 1,5	26,9	34	26	23,8	2,0	2,4	18,0	15,5	15°
M 26 x 1,5	30,9	37	31	29,05	2,0	3,1	18,5	16,0	15°
M 27 x 2	31,9	40	32	29,4	2,0	3,1	22,0	19,0	15°
M 33 x 2	37,9	46	38	35,4	2,5	3,1	22,0	19,0	15°
M 42 x 2	47,9	56	47	44,4	2,5	3,1	22,5	19,5	15°
M 48 x 2	54,9	64	53	50,4	2,5	3,1	25,0	22,0	15°

UNF / UN-Gewinde (= SAE J 514, ISO 11926) UNF / UN-thread (= SAE J 514, ISO 11926)

d1	d5	d4 _{min}	d3	d2 _{+0,1}	a1 _{max}	a2	t1 _{min}	b1 _{min}	± α 1°
7/16-20 UNF	14,4	21	15	12,4	1,6	2,4	14,0	11,5	12°
9/16-18 UNF	17,6	25	18	15,6	1,6	2,5	15,5	12,7	12°
3/4-16 UNF	22,3	30	23	20,6	2,4	2,5	17,5	14,3	15°
7/8-14 UNF	25,5	34	26	23,9	2,4	2,5	20,0	16,7	15°
1.1/16-12 UN	31,9	41	32	29,2	2,4	3,3	23,0	19,0	15°
1.5/16-12 UN	38,2	49	39	35,5	3,2	3,3	23,0	19,0	15°
1.5/8-12 UN	47,7	58	48	43,5	3,2	3,3	23,0	19,0	15°
1.5/8-12 UN	47,7	58	48	43,5	3,2	3,3	23,0	19,0	15°

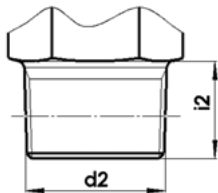

Einschraubzapfen NPT

Stud end NPT

- Abdichtung durch Kegeltgewinde
 - Taper thread
- (ANSI/ASME B1.20.1)

NPT

d2	t2
1/8-27 NPT	10
1/4-18 NPT	15
3/8-18 NPT	15
1/2-14 NPT	20
3/4-14 NPT	20
1-11,5 NPT	25
1.1/4-11 1/2 NPT	25
1.1/2-11 1/2 NPT	26

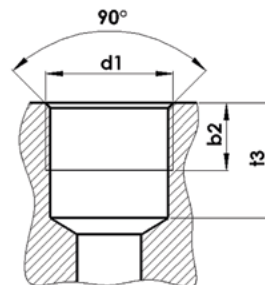

Einschraubloch NPT

Port NPT

- für NPT Einschraubzapfen
 - for NPT stud ends
- (ANSI/ASME B1.20.1)

NPT

d1	t3	b2
1/8-27 NPT	8	12
1/4-18 NPT	11	16
3/8-18 NPT	12	17
1/2-14 NPT	15	22
3/4-14 NPT	16	23
1-11,5 NPT	19	27
1.1/4-11 1/2 NPT	20	28
1.1/2-11 1/2 NPT	20	28

Metrische Gewindeanschlüsse

Metric thread informations

Sonstige zöllige Gewinde Other Inch Threads

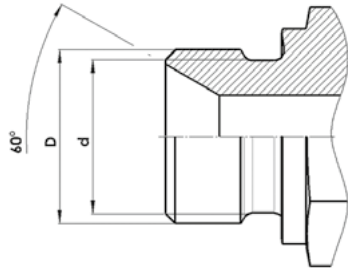

BSPP			
Gewinde Thread	Gänge/Zoll TPI	D	d
G 1/8"	28	9,7	8,6
G 1/4"	19	13,1	11,5
G 3/8"	19	16,6	14,9
G 1/2"	14	20,9	18,6
G 3/4"	14	26,4	24,1
G 1"	11	33,2	30,8
G 1.1/4"	11	41,9	39,3
G 1.1/2"	11	47,8	45,2
G 2"	11	59,6	56,7

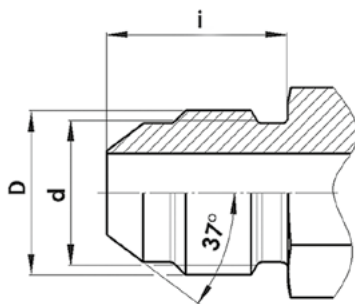

UNF/UN für JIC for JIC

Gewinde Thread	DN	Dash	D	d	i
7/16-20 UNF	6	-4	11,0	10,0	14
1/2-20 UNF	8	-5	12,5	11,5	14
9/16-18 UNF	10	-6	14,2	12,9	14,1
3/4-16 UNF	12	-8	18,9	17,5	16,7
7/8-14 UNF	16	-10	22,1	20,4	19,3
1.1/16-12 UN	20	-12	26,8	24,9	21,9
1.5/16-12 UN	25	-16	33,2	31,2	23,1
1.5/8-12 UN	32	-20	41,1	39,1	24,3
1.7/8-12 UN	38	-24	47,5	45,6	27,5
2.1/2-12 UN	50	-32	63,4	61,5	33,9

Französische Norm GAZ Anschluss French standard GAZ connector

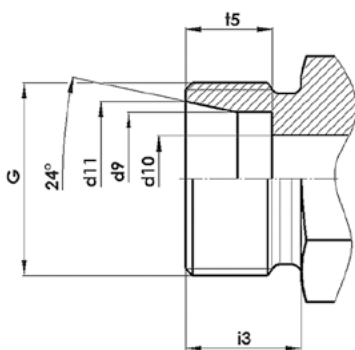

GAZ							
Reihe Series	Rohr AD Tube OD	G	d9	d10	d11	t5	i3
GAZ 13	1/4"	M 20x1,5	13,8	9	16,1	9	12
GAZ 17	3/8"	M 24x1,5	17,35	12	19,6	9	12
GAZ 21	1/2"	M 30x1,5	21,4	15	23,7	9	14
GAZ 27	3/4"	M36x1,5	27	21	29,3	9	14
GAZ 33	1"	M 45x1,5	34,1	26	36,5	9	16
GAZ 42	1.1/4"	M 52x1,5	42,9	33	45,3	9	16
GAZ 49	1.1/2"	M 58x2	48,9	40	51,5	11	16

Rohranschlussmaße für Stutzen

Gewindezapfen nach DIN EN ISO 8434-1
Bohrungsform W nach DIN 3861

24° cutting ring cone end for tube couplings

Standard dimensions of bore form W acc. to DIN 3861, ISO 8434-1

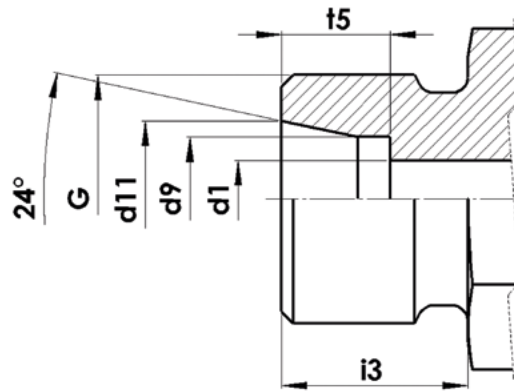

Baureihe
Series

			G	d ₁	d ₉	d ₁₁	i ₃	t ₅
LL	4	100	M 8 x 1	3	4	5,0	8	4,0
	6		M 10 x 1	4,5	6	7,5	8	5,5
	8		M 12 x 1	6	8	9,5	9	5,5
L	6	315	M 12 x 1,5	4	6	8,1	10	7,0
	8		M 14 x 1,5	6	8	10,1	10	7,0
	10		M 16 x 1,5	8	10	12,3	11	7,0
	12		M 18 x 1,5	10	12	14,3	11	7,0
	15		M 22 x 1,5	12	15	17,3	12	7,0
	18	M 26 x 1,5	15	18	20,3	12	7,5	
	22	160	M 30 x 2	19	22	24,3	14	7,5
	28		M 36 x 2	24	28	30,3	14	7,5
35	M 45 x 2		30	35	38,0	16	10,5	
42		M 52 x 2	36	42	45,0	16	11,0	
S	6	630	M 14 x 1,5	4	6	8,1	12	7,0
	8		M 16 x 1,5	5	8	10,1	12	7,0
	10		M 18 x 1,5	7	10	12,3	12	7,5
	12		M 20 x 1,5	8	12	14,3	12	7,5
	14		M 22 x 1,5	10	14	16,3	14	8,0
	16	400	M 24 x 1,5	12	16	18,3	14	8,5
	20		M 30 x 2	16	20	22,9	16	10,5
	25		M 36 x 2	20	25	27,9	18	12,0
	30		M 45 x 2	25	30	33,0	20	13,5
	38		315	M 52 x 2	32	38	41,0	22

Volumenstrom

Hydraulikschläuche sind hochflexible Verbindungen mit beiderseitigen Anschlussarmaturen. Unten stehende Tabellen sollten vor Festlegung der Schlauchleitung genauestens durchgelesen und berücksichtigt werden. Bei der Festlegung einer Schlauchleitung empfehlen wir, wie folgt vorzugehen:

- 1. Um die Nennweite (DN) festzulegen benötigt man die Fördermenge der Pumpe in Liter und die Strömungsgeschwindigkeit. Da die Pumpenhersteller diese in cm³ angeben, muß nach folgender Formel gerechnet werden:

$$\text{Volumenstrom} \left(\frac{\text{l}}{\text{min}} \right) = \frac{\text{Fördermenge Output (cm}^3\text{)} \times \text{Motordrehzahl Motor revolutions (min}^{-1}\text{)}}{1000}$$

Beispiel:

$$\frac{25(\text{cm}^3) \times 3000(\text{min}^{-1})}{1000} = 75 \left(\frac{\text{l}}{\text{min}} \right)$$

- 2. Die Festlegung der Schlauchtype ist vom max. Betriebsdruck und der Einstellung des Überdruckventils abhängig. Maßgebend ist der dynamische Betriebsdruck des Schlauches. Da es bei Hydrauliksystemen während der Umschaltvorgänge zu Spitzendrücken kommen kann, sollte dies bei den max. Drücken unbedingt berücksichtigt werden.
- 3. Um eine optimale Lebensdauer der Schlauchleitung zu erreichen, empfehlen wir die Einbauvorschriften des Herstellers zu beachten und einzuhalten.

Flow volume

Hydraulic hoses are flexible connections suitable for high pressures with hydraulic couplings at each end. In order to establish the sort and size of hose required for an application, and therefore which hose fitting and ferrule should be ordered from Volz, the following information should be taken into consideration.

- 1. To decide the hose inside diameter (DN), the flow rate needs to be calculated. This can be done using the following formula.

- 2. To select the type of hose required, the maximum operational pressure of the system must be known. The determining figure is the dynamic operational pressure of the system. Peak pressures can occur in hydraulic systems and these must be taken into consideration.
- 3. We recommend that the manufacturer's assembly instructions are followed carefully to achieve the longest possible hose durability.

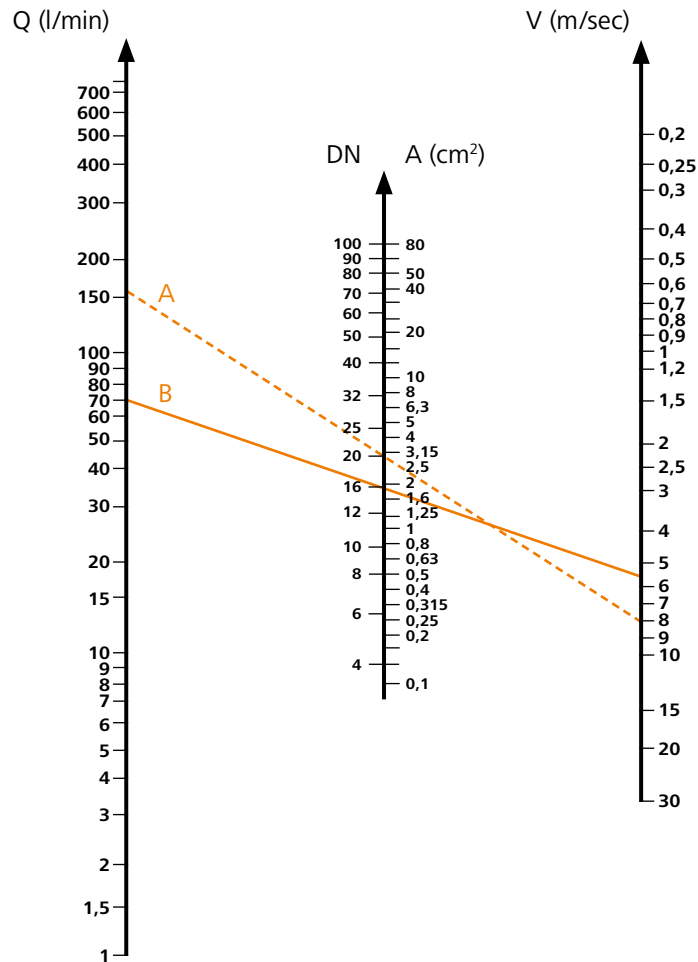

Nomogramm zur Bestimmung der Schlauch-Nennweite

Dieses Nomogramm gibt einen Anhaltspunkt bei der Bestimmung der für eine Schlauchleitung erforderlichen Nennweite (DN).

- Beispiel A: Man wählt eine Geschwindigkeit $v = 8$ m/s und eine Durchflussmenge $Q = 150$ l/min.

Die geradlinige Verbindung dieser beiden Werte auf den äußeren Skalen ergibt auf der mittleren Skala die Schlauch-nennweite DN 20.

- Beispiel B: Man wählt eine Geschwindigkeit $v = 5,5$ m/s und eine Durchflussmenge $Q = 66$ l/min.

Die geradlinige Verbindung dieser beiden Werte auf den äußeren Skalen ergibt auf der mittleren Skala die Schlauch-nennweite DN 16.

Der Widerstand der Rohre, der Krümmen und Ventile sowie Viskosität, Temperatureinflüsse auf die Viskosität und andere Faktoren sind nicht berücksichtigt.

Chart for determining the hose ID (DN)

The above chart can be used as guide for selecting the required hose inside diameter (DN).

- Example A: A flow velocity of $V = 8$ m/s is selected from right hand scale and a flow rate of $Q = 150$ l/min from the left hand scale.

A straight line linking these two values intersects the DN value on the centre scale. In this case $DN = 20$.

- Example B: A flow velocity of $V = 5,5$ m/s is selected from right hand scale and a flow rate of $Q = 66$ l/min from the left hand scale.

A straight line linking these two values intersects the DN value on the centre scale. In this case $DN = 16$.

Please note that both above examples are approximate. No allowance has been made for adverse factors such as friction and interference from tube walls, elbows, valves or viscosity, temperature or other factors.

Längentoleranz bei montierten Schlauchleitungen

Die erwartete Lebensdauer einer Schlauchleitung ist abhängig von der ordnungsgemäßen Bemessung und Montage. Dies beinhaltet auch die richtige Bestimmung der Schlauchlänge. Bitte dies bei der Bestellung von Volz-Schlauchschnippeln beachten.

Hose dimensions – General information

The expected life of a hose assembly depends on the correct installation. This in turn is dependent on the correct hose assembly lengths. Please take this into consideration when ordering Volz hose fittings.

■ Ermittlung der Schlauchlänge

$$\text{Länge} = 2 \cdot A + x$$

$$x = \pi \cdot R$$

R = Mindestbiegeradius

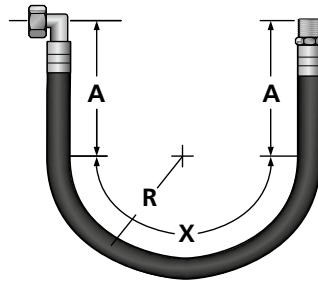

■ Calculating the correct hose length

$$\text{Length} = 2 \cdot A + x$$

$$x = \pi \cdot R$$

R = Min. bend radius

(see hose manufacturers catalogue)

Fest installierte Schlauchleitungen

Um Knickbeanspruchungen an den Anschlussarmaturen zu vermeiden und eine maximale Funktionstüchtigkeit von Schlauchleitungen zu gewährleisten, sind beide Schlauchenden gerade zu verlegen. Deshalb empfehlen wir, bei der Längenberechnung gemäß obiger Abbildung zu verfahren, wobei (R) > = dem Mindestbiegeradius + 1/2 Schlauchdurchmesser sein muß.

Fixed hose connections

To avoid stress caused by kinking at the connecting fittings and to assure the most efficient hose function, both ends of the hose should be fitted straight. For this reason we suggest that the calculation of the length should be done according to the above illustration, whereby (R) > = must be the minimum curve radius + 1/2 hose diameter.

Toleranzen **Tolerances**

Länge Length	bis DN 25 up to inside dia. 25 (DN)	ab DN 32 bis DN 50 from DN 32 to DN 50	ab DN 60 bis DN 100 from DN 60 to DN 100
< 630 mm	- 3 mm / +7 mm	-4 mm / +12 mm	-6 mm / +25 mm
630 mm - 1250 mm	-4 mm / +12 mm	-6 mm / +20 mm	-6 mm / +25 mm
1250 mm - 2500 mm	-6 mm / +20 mm	-6 mm / +25 mm	-6 mm / +25 mm
2500 mm - 8000 mm		-0,5% / +1,5%	-0,5% / +1,5%
8000 mm >		-1% / +3%	-1% / +3%

Die Fertigungstoleranzen entsprechen DIN 20066 The production tolerances are according to DIN 20066

Längentoleranz bei montierten Schlauchleitungen

Hose dimensions – General information

- Ermittlung der Schlauchlänge
 $Length = 2 \cdot A + x + T$
 $x = \pi \cdot R$
 R = Mindestbiegeradius
 (siehe Kataloge der Schlauchhersteller)
 T = Hubbewegung

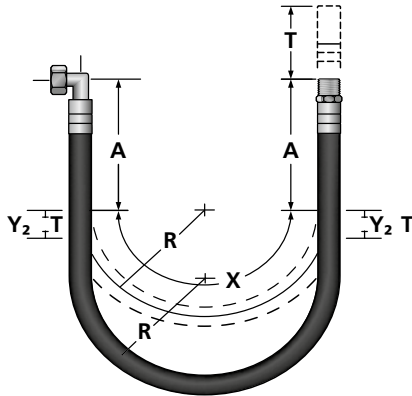

- Calculating the correct hose length
 $Length = 2 \cdot A + x + T$
 $x = \pi \cdot R$
 R = Minimum bending radius
 (see hose manufacturers catalogue)
 T = Stroke

Flexibel installierte Schlauchleitungen

Flexible hose connections

Bei der Berechnung von flexibel installierten Schlauchleitungen gelten die gleichen Einbauhinweise wie unten stehend, jedoch ist bei Hubbewegungen die entsprechende zusätzliche Länge (T) zu berücksichtigen.

To calculate the length of flexibly installed hose the same fitting procedure should be used as shown in the above drawing, however corresponding additional length (T) should be allowed for the lifting movements.

Die zu belassende Mindestlänge (A) hinter beiden Armaturenden einer Leitung ist aus nachstehender Tabelle ersichtlich. Bei jeder kompletten Leitung ist also das Maß (A) zweimal zu berücksichtigen. Bei Bogenarmaturen vergrößert sich das Maß (A) um 50%.

The minimum length (A) that should be left behind the fittings can be seen on the table below. This means that for each complete hose connection, the dimension (A) should be allowed twice. If elbow fittings are used the dimension (A) increases by 50%.

Mindestlänge (A) hinter Armaturenden		Minimum length (A) behind the fittings									
Nennweite Nominal width		6	8	10	12	16	20	25	32	40	50
A (mm)		90	100	110	120	130	140	160	180	200	250

Messbeispiele für Schlauchleitungen

Measuring examples for hose connections

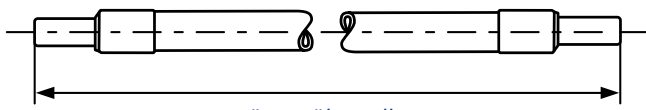

Länge über alles
Overall length

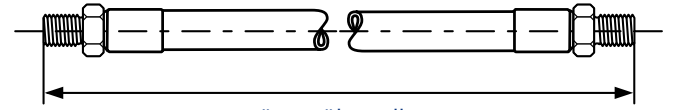

Länge über alles
Overall length

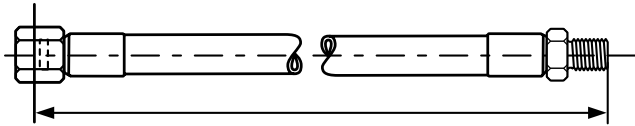

Länge über Dichtkegel / Außengewinde
Overall length over female swivel / male

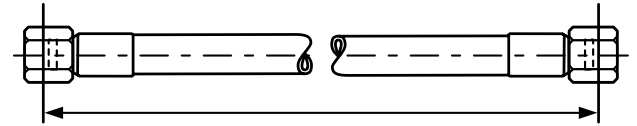

Länge über Dichtkegel
Overall length over female swivel

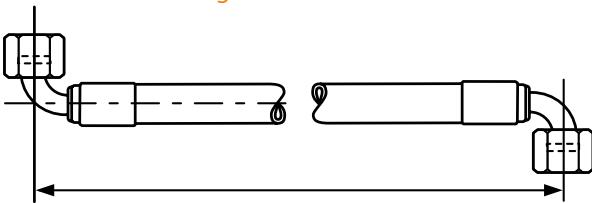

Länge zwischen Dichtkegelmittelpunkten
Length between centres of female connections

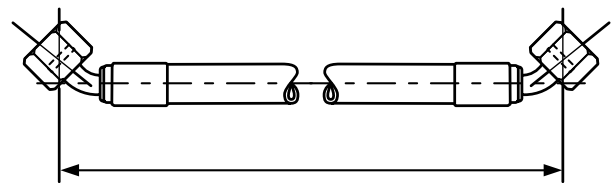

Länge zwischen Dichtkegelmittelpunkten
Length between centres of female connections

Verdrehwinkel

Winkelversatz bei zwei Bogenarmaturen:

Angle of torsions

Angle relationship for two elbow fittings:

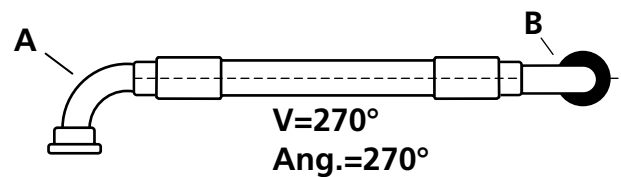
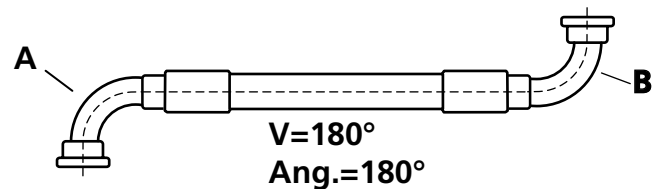
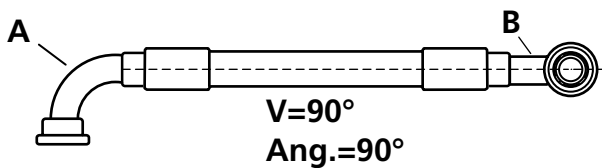
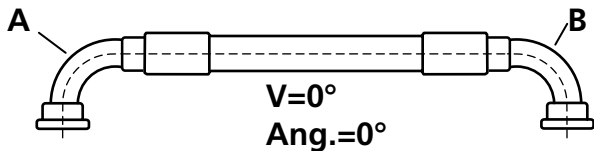

- Die in der Beschreibung einer Leitung zuerst genannte Bogenarmatur (A) zeigt immer nach vorne/unten.
- Die zuletzt genannte Bogenarmatur (B) wird zu der ersten gegen den Uhrzeigersinn um x° versetzt.

- Elbow "A" in the above diagrams is always position up or down.
- Elbow "B" in the above diagrams is rotated anti-clockwise by x° .

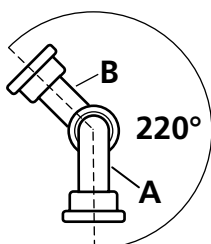

- Toleranz: $\pm 3^\circ$
- Tolerance $\pm 3^\circ$

- Beispiel: 4SP DN 20 x 1000 SFS 90° / SFS 90° - $\leq 220^\circ$
- Example: 4SP Dia. 20 x 1000 SFS 90° / SFS 90° - $\leq 220^\circ$

Grundregeln für das Verlegen von Schlauchleitungen

1. Schlauchleitungen mit Durchhang verlegen, (richtige Schlauchlänge ermitteln).
2. Beim Einbau nicht verdrehen (Torsion).
3. Schlauchleitungen nicht übermäßig krümmen, (Bogenarmaturen verwenden).
4. Den Mindestbiegeradius einhalten.
5. Bei Hubbewegungen den Hub berücksichtigen.
6. Gegen äußere Beschädigungen schützen (Knickschutzspiralen verwenden).

Basic rules for fitting hose connections

1. Hose should always be installed with a wide radius bend, (it is important that the hose is long enough).
2. Do not kink hose (Torsion).
3. Do not bend the hose too much (use elbow fittings).
4. Allow for minimum bend radius.
5. Allow enough "play" for a dynamic installation
6. Protect against damage from other influences (use kink spirals).

Einbaubeispiele (DIN 20066)

Fitting examples (DIN 20066)

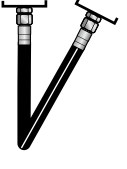
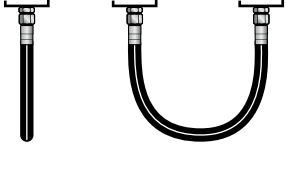
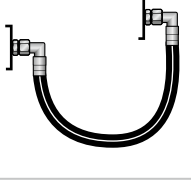
<p> Falsch Wrong</p> 		<p>■ Verbesserung durch Zwischenstück ■ Improvement with adaptor</p>	<p> Richtig Right</p> 
<p> Falsch Wrong</p> 		<p>■ Verbesserung durch Zwischenstücke, jedoch Schlauch zu sehr unter Spannung ■ Improvement with adaptor, however hose under too much stress</p>	<p> Richtig Right</p> 
<p> Falsch Wrong</p> 	<p> Richtig Right</p> 		
<p> Falsch Wrong</p>  <p>■ Schlauchleitung wird Torsion ausgesetzt ■ hose subject to torsion</p>	<p> Richtig Right</p> 		
<p> Falsch Wrong</p>  <p>■ Vermehrte Biegebelastung durch Vibration ■ Increased bending strain due to vibration</p>	<p> Richtig Right</p> 		
<p> Falsch Wrong</p>  <p>■ Torsionsbeanspruchung und zu kurz bemessene Schlauchleitung ■ Torsion strain, and the hose connection ist too short</p>	<p> Richtig Right</p> 		

Druckverlust in Schlauchleitungen

Druckverlust in Millibar (mbar) bei 1 m Schlauchlänge ohne Armaturen und Durchflussmengen von 1 bis 1000l/min.

- Spezifikation des Mediums: spez. Gew. 0,85
- kinematische Zähigkeit = 20 centistokes (cSt)
- entsprechend MIL-H-5606 bei + 21 °C (+70 °F)

Abmessungen in mm: **fett** gedruckt

Zollabmessungen: mager gedruckt

Hose pressure drop

Pressure drop is expressed in millibar (mbar) per 1 meter length of hose (smooth bore) without fittings and flow rate from 1 to 1000l/min.

- Fluid spec. specific gravity = 0,85
- Viscosity = 20 centistokes (cSt)
- ref MIL-H-5606 at + 21 °C (+70 °F).

Dimensions in mm: bold type

Inch measures: light type

DN nach DIN DN acc. DIN	5	6	8	10	12	16	20	25	32	40	50	60	70									
DN (real)	4,8	6,4	6,4	8,0	9,5	10,3	12,7	12,7	15,9	15,9	19,0	22,2	25,4	28,6	31,8	35,0	38,1	46,0	50,8	60,3	76,2	
Schlauchgröße Hose Size	-4	-5	-6	-8	-10	-12	-16	-20	-24	-32	-40	-48										
1	242	75,4	75,4																			
2	466	146	146	66,1																		
4	996	293	293	133	58,6																	
8	2433	613	613	25,	117	85																
10	3540	880	880	335	144	103	45,4	45,4														
15		1776	1776	660	273	182	68,6	68,6	27,4	27,4												
20		3080	3080	1129	462	308	116	116	41,4	41,4	18,1											
30				2159	887	592	228	228	81,8	81,8	31,8	13,6										
40					1496	1000	379	379	141	141	50,0	26,3	14,0									
50						1414	555	555	192	192	75,0	41,1	21,5	12,1								
60						1938	756	756	263	263	111	55,9	29,6	15,6	9,87							
70							970	970	373	373	154	71,4	37,4	18,3	13,3	8,51						
80							1250	1250	475	475	200	89,5	49,1	28,0	16,8	11,0	6,91					
90							1531	1531	560	560	237	115	66,0	34,1	21,1	13,5	8,50	3,61				
100									653	653	274	137	73,1	40,8	25,1	15,8	10,0	4,25	2,71			
125									964	964	393	196	103	59,2	35,6	22,7	14,5	5,78	3,79			
150											567	273	147	77,4	49,8	31,8	19,4	8,57	5,44			
175											735	349	186	106	60,4	41,0	26,5	11,0	7,12	3,06		
200											920	431	228	136	83,3	51,4	33,3	13,8	8,63	3,79		
250												642	347	198	124	78,5	49,9	20,8	13,2	6,01		
300												864	475	272	162	105	68,2	27,4	17,3	7,77	2,52	
400													832	483	303	177	118	47,7	32,4	13,9	4,54	
500														1159	690	425	250	164	66,0	43,3	19,4	6,38
600																562	339	222	88,6	57,4	25,8	8,49
700																733	461	301	120	78,2	34,6	11,2
800																924	584	383	151	98,4	43,4	13,8
900																1144	706	468	182	118	53,2	16,2
1000																	841	553	219	140	67,5	19,6

Umrechnungstabelle Conversion table

Zeichen Symbol	Bezeichnung Designation	Einheit Unit	Umrechnungsfaktor Conversion factor
B, H, L	Maßangaben Dimensions	mm	1 Inch = 25,4 mm
P	Druck Pressure	MPa	1 psi = 0,007 MPa 1 bar = 0,1 MPa
Δ P	Druckdifferenz Differential pressure	MPa	1 psi = 0,07 bar 1 bar = 14,286 psi
T	Temperatur Temperature	°C	1°F = 9/5 x °C + 32 °K = °C + 273
Mt	Drehmoment Torque	Nm	1 lb Inch = 0,115 Nm
Q	Durchfluss Flow	l/min	1 US gall/min = 3,785 l/min 1 UK gall/min = 4,546 l/min
W	Gewicht Weight	Kg	1 lb = 0,4536 Kg

Dichtungswerkstoffe Sealing materials

Werkstoffbezeichnung Material description	Handelsname Trade name	Temperaturbereich Temperature range	Verwendungszweck	Applications
NBR Acrylnitril-Butadien-Kautschuk Acrylonitrile-Butadiene-Rubber	Perbunan Buna N Hycar Chemigum	-30°C bis +100°C	Gute technologische Eigenschaften, besonders für Öle und gasförmige Medien	Good technical properties, therefore especially suitable for oils and gaseous mediums
FPM Fluor-Kautschuk Fluor-Rubber	Viton Fourel Tecnoflon	-25°C bis +200°C	Hohe chemische Stabilität gegen viele Medien, besonders Mineralöle, Kraftstoffe, und konzentrierte Säuren	High chemical resistance to various mediums, in particular mineral oils, fuels and concentrated acids
EPDM Äthylen-Propylen-Dien-Kautschuk Äthylen-Propylen-Dien-Rubber	Buna AP Nordel	-50°C bis +130°C	Gute Alterungsbeständigkeit, geringer Abrieb – besonders geeignet für Acetylen, Bremsflüssigkeiten, Heißwasser und Heißdampf, kühle Gase, schwerentflammare Flüssigkeiten auf Phosphorsäureesterbasis	Good ageing stability, low wear, especially suitable for acetylene, brake fluids, hot water and superheated steam, cooling gases, low-flammable liquids based upon Phosphoric acid
PTFE Polytetrafluorethylen Polytetrafluorethylene	Teflon Hostflon Fluon	-60°C bis +200°C	Hervorragende chemische Beständigkeit bei fast allen Medien, keine Wasseraufnahme, gute Gleitfähigkeit	Excellent chemical resistance to almost all fluids, no water absorption low surface friction
POM Polyacetal Polyacetal	Delrin Hostaform C Ultraform	-30°C bis +100°C	Hohe Druck- und Abriebfestigkeit, geringe Wasseraufnahme, besonders geeignet für Hydrauliköle, sonstige Öle und schwer entflammare Flüssigkeiten	High pressure and wear resistance, low water absorption, particularly suitable for hydraulic oils, other oils and water based hydraulic fluids



Die Zukunft in Zink-Nickel ist glänzend! **Zinc-nickel has a bright future!**

Gemäß der Europäischen Richtlinie Nr. 2000/53/EG wird der Verzicht auf Chrom(VI)-haltige Komponenten auf Grund des Gesundheits- und Umweltschutzes seit dem 01.07.2007 in PKW < 3,5t vorgeschrieben. Darüber hinaus haben nahezu alle Hersteller von stationären und mobilen Geräten sich dieser Richtlinie angeschlossen.

Anforderungen bzgl. des Korrosionsschutzes sind im gleichen Zeitraum deutlich angestiegen, insbesondere in der Mobilhydraulik. So sind Werte aus dem Salzsprühnebeltest nach DIN EN ISO 9227 mit 96 Stunden heute nicht mehr akzeptabel. Die Volz Gruppe GmbH bietet mit der optimierten Zink-Nickel-Beschichtung für die MF-Stahlprodukte aktuell eine Korrosionsbeständigkeit von > 1.200 Stunden.

Die Anforderungen der REACH und RoHS werden dabei erfüllt.

European Directive 2000/53/EC prohibits the use of components containing hexavalent chromium in passenger cars < 3.5 t. For reasons of health and environmental protection this directive has been effective since 01.07.2007. Almost all manufacturers of stationary and mobile hydraulic equipment have adopted this directive.

At the same time, the demands for corrosion protection have increased greatly, particularly in mobile hydraulics. For example, values of 96 hours in the salt-spray test to DIN EN ISO 9227 are no longer acceptable today. With its optimised zinc-nickel coating, Volz Gruppe GmbH currently offers corrosion resistance of > 1.200 hours with our MF brand fittings.

The requirements of REACH and RoHS are met in this context.



Gründe für eine optimierte galvanische Oberflächenbeschichtung:

- Wachsende Anforderungen aus dem Markt insbesondere bei mobilen Anwendungen, die ein offensichtliches Interesse daran haben, Korrosion zu vermeiden.
- Darüber hinaus sehen sich auch stationäre Anwendungen auf internationalen Märkten mit neuen Herausforderungen konfrontiert. Wind und Wetter, Luftfeuchtigkeit, aber auch salzhaltige oder verschmutzte Luft tragen zur beschleunigten Korrosion bei.

Volz Lösung für diese Herausforderungen:

Der Schichtaufbau der Volz ZnNi-Beschichtung, einer galvanischen Beschichtung aus Zink, mit einem anteiligen Nickelgehalt von 12-15 %.

Eigenschaft: Die Zink-Nickel-Basissschicht weist eine Schichtdicke von 8 µm auf. Die Farbgebung wird überwiegend durch die zusätzliche Passivierungsschicht von ca. 500 nm erreicht sowie einer zusätzlichen Versiegelung von 2 µm. Optisch sind die Komponenten ansprechend, hell und leicht glänzend. Vergleichbar mit hochwertigem Edelstahl. Eine homogene Verteilung der ZnNi-Moleküle in der Basissschicht erreichen wir durch einen höheren Wirkungsgrad beim Beschichtungsvorgang von ca. 98 % gegenüber 40 % bei herkömmlichen Verfahren.

Reasons for the optimised electroplated surface coating:

- Growing demands from the market in mobile applications in particular which have an obvious interest in avoiding corrosion.
- Stationary applications are likewise being confronted with new challenges by weather, atmospheric humidity, and also salty or polluted air and they all contribute to accelerated corrosion.

The Volz answer to this challenge:

The layered structure of the Volz ZnNi coating of zinc combined with a nickel content of 12-15 %.

Feature: The zinc-nickel base layer has a thickness of 8 µm. The colour is predominantly achieved by the additional passivation layer with a thickness of approx. 500 nm and an additional sealing layer of 2 µm. The components have an attractive appearance – bright and slightly glossy, comparable to high-grade stainless steel. The homogeneous distribution of the ZnNi molecules in the base layer is achieved as a result of a better efficiency in control of the deposition process (approx. 98 % efficiency compared to the 40 % of conventional processes).

Die Eigenschaften der Volz ZnNi-Beschichtung

1. Erhöhte Korrosionsschutzleistung

■ **Vorteil:** Die optimierte Volz Zink-Nickel Beschichtung übertrifft Korrosionsschutzwerte von > 1.200 Stunden gegenüber Weißrost. Getestet wird gem. DIN EN ISO 9227.

Anmerkung: Die im Einheitsblatt VDMA 24576 unter der Korrosionsschutzklasse K5 geforderten Werte von 360/720 Stunden bis Auftreten von Weiß-/Rotrost werden bei weitem übertroffen.

■ **Eigenschaft:** Versiegelung und Passivierung schützen die ZnNi-Oberfläche und verzögern die Weißrostbildung. Transport, Handling und Montage können zu einer mechanischen Beschädigung der Versiegelung und Passivierung führen. Die dann freiliegende ZnNi-Basissschicht ist gegenüber freiliegenden Reinzinkschichten wesentlich korrosionsbeständiger. Daher weist die Volz ZnNi-Schicht eine deutlich höhere Korrosionsschutzwirkung auf.

2. Verminderte Kontaktkorrosion mit anderen Metallen

■ **Vorteil:** In Verbindung mit Aluminium und Edelstahl weisen ZnNi-Beschichtungen die geringste Kontaktkorrosion auf. In der praktischen Spannungsreihe weist die Volz ZnNi-Schicht eine deutlich geringere Potentialdifferenz zu Stahl, Aluminium und Edelstahl als reine Zinkschichten auf.

Anmerkung: Bei Potentialdifferenzen > 0,3 V tritt verstärkt Kontaktkorrosion auf. Zink-Elektrolyte besitzen deutlich höhere Ausgangswerte (und damit Potentialdifferenzen) als ZnNi-Elektrolyte, und damit anfälliger für eine deutlich frühere Kontaktkorrosion.

3. Wasserstoff-Versprödung ist deutlich reduziert

■ **Vorteil:** Durch den hohen Wirkungsgrad von ca. 98 % entstehen im Vergleich zu herkömmlichen Verfahren mit 40 % Wirkungsgrad keine nennenswerten Anteile Wasserstoff während der Elektrolyse. Ein positiver Effekt der optimierten Beschichtung.

The features of the Volz ZnNi coating

1. Enhanced Corrosion resistance performance

■ **Advantage:** The optimised Volz zinc-nickel coating has demonstrated values in excess of 1,200 hours corrosion protection against white rust during testing in accordance with DIN EN ISO 9227.

Note: Current values of 360/720 hours before white/red rust occurs, as called for by Corrosion Protection Class K5 in VDMA-Einheitsblatt 24576, are easily surpassed with this coating.

■ **Feature:** Sealing and passivation protect the ZnNi surface and delay the formation of white rust. Transport, handling and assembly can result in mechanical damage to the sealing and the passivation layer. In such case the ZnNi base layer which may be exposed is far more corrosion-resistant than exposed pure-zinc coatings. Consequently, the Volz ZnNi layer displays significantly enhanced anticorrosion characteristics.

2. Reduced Contact corrosion with other metals

■ **Advantage:** ZnNi coatings display significantly reduced contact corrosion in conjunction with aluminium and stainless steel. In the practical electrochemical series, the Volz ZnNi layer demonstrates a much smaller potential difference than pure zinc layers, relative to steel, aluminium and stainless steel.

Note: Increased contact corrosion occurs at potential differences > 0.3 Volts. Zinc electrolytes display considerably higher starting values (and thus potential differences) than ZnNi electrolytes, and thus are susceptible to considerably earlier contact corrosion.}

3. Hydrogen embrittlement is greatly reduced

■ **Advantage:** As a result of the greater efficiency of zinc particle layering, no significant amounts of hydrogen are produced during electrolysis in comparison with conventional processes. This is a positive effect of the optimised coating.

4. Verbesserte Systemleistungen – mechanische Eigenschaften

■ **Vorteil:** Volz optimierte Zink-Nickel-Oberfläche weist durch ihre hohe Duktilität als auch Oberflächenhärte optimale Bedingungen bei Handhabung und Montage der Verschraubungskomponenten auf. Plastische Verformbarkeit als auch Abriebfestigkeit der Beschichtung übertreffen die Anforderungen.

5. Überlackierbarkeit

■ **Vorteil:** Eine Überlackierbarkeit ist grundsätzlich möglich. Bei konkreten Anforderungen an die Lackqualität muss die Oberfläche unter Umständen behandelt werden.

Bitte beachten Sie: Stahl-Überwurfmutter der Volz Gruppe GmbH sind mit einer Gleitbeschichtung versehen. Zweck der Beschichtung ist es, die Reibwerte bezogen auf die Montage einzustellen. Es handelt sich um eine nicht-kennzeichnungspflichtige, umweltfreundliche, silikonfreie, gelblich-transparente Suspension von hellfarbenen Festschmierstoffen in Wasser.

Da es sich um ein Gleitmittel handelt, empfehlen wir einen Lackversuch und ggf. ein Entfetten der zu lackierenden Flächen.

6. Reduziertes Allergierisiko

Nickel ist als Allergieauslöser in der Diskussion. Dieses Metall kommt praktisch überall in unserer Umwelt vor. So ist Nickel im Wasser, in Hülsenfrüchten oder Vollkornprodukten zu finden. Der direkte Kontakt zu Nickel auf der Oberfläche der Verschraubungen ist im gleichen Maße wie in sämtlichen Haushaltsgeräten wie z.B. Töpfen, Besteck oder auch unserem Zahlungsmittel, dem Euro gegeben. Der Euro beispielsweise enthält zu 25 % Nickel.

■ **Vorteil:** Im Gegensatz dazu enthält die Oberfläche der Volz-Bauteile nur zu max. 16 % Nickelanteile. Diese werden zudem durch die Passivschicht und die Versiegelung abgedeckt und verhindern einen direkten Körperkontakt.

Vorteile der Volz MF Produkte:

- **Deutlich erhöhter Korrosionsschutz**
- **Deutlich reduzierte Kontaktkorrosion**
- **Einfache Montage**
- **Ein umweltfreundliches Produkt**

4. Enhanced mechanical properties

■ **Advantage:** Thanks to its high ductility combined with surface hardness, the Volz optimised zinc-nickel surface offers improved handling when assembling tube fitting components. The coating's plastic deformability and abrasion resistance sets new standards and exceeds the current requirements.

5. Over painting properties

■ **Advantage:** Over painting is possible. However, it may be necessary to treat the surface if the quality or type of the paint coating has to meet specific requirements.

Please Note: Steel nuts from Volz Gruppe GmbH are provided with a lubricant coating. The purpose of this coating is to set the coefficients of friction required for assembly. The coating is an environmentally friendly, silicone-free, yellowish-transparent suspension of light-coloured solid lubricants in water and is not subject to compulsory labelling. Since it is a lubricant, we recommend a painting test and, if necessary, degreasing of the surfaces to be painted in accordance with the paint manufacturers recommendations.

6. Reduced Allergy risks

Nickel is a subject of debate as a trigger of allergies. This metal is almost ubiquitously present in our environment. Nickel is to be found in water, pulses or wholegrain products, as examples. Direct contact with nickel on the surface of the tube fittings is similar to that in many household items, such as saucepans and cutlery. It is of note that Euro coins contain up to 25 % nickel.

■ **Advantage:** The surface of Volz components have a maximum nickel content of 16 % and in addition, the zinc-nickel coating is covered by both a passivation layer and sealing layer to reduce any direct physical contact

Benefits of Volz MF Products:

- **Greatly Enhanced Corrosion Resistance**
- **Greatly reduced Contact Corrosion**
- **Easier Assembly**
- **An Environmentally friendly product.**

Schlaucharmaturen **Hose Fittings**



Übersicht Visual Index

DKO

Seite [page 41](#)



DKO 45°

Seite [page 42](#)

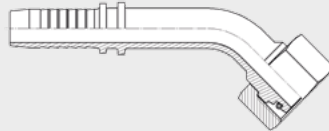

DKO 90°

Seite [page 43](#)

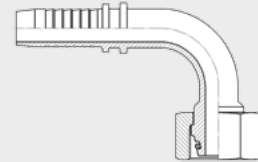

DKLL / DKL / DKS

Seite [page 44](#)

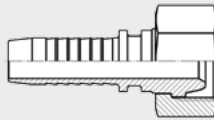

DKLL / DKL / DKS 45°

Seite [page 45](#)

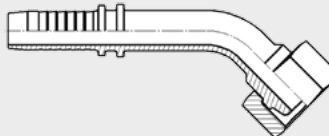

DKLL / DKL / DKS 90°

Seite [page 46](#)

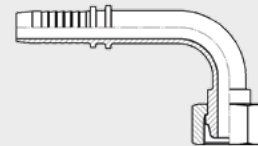

**BE
(Metric Standpipe)**

Seite [page 47](#)



**BE 45°
(Metric Standpipe 45°)**

Seite [page 48](#)

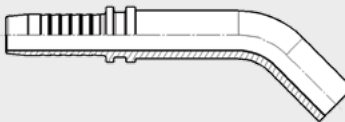

**BE 90°
(Metric Standpipe 90°)**

Seite [page 49](#)

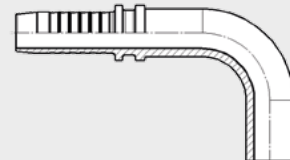

**DKR
(BSPP Female)**

Seite [page 50](#)

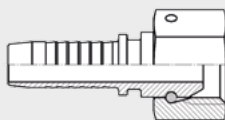

**DKR 45°
(BSPP Female 45°)**

Seite [page 51](#)

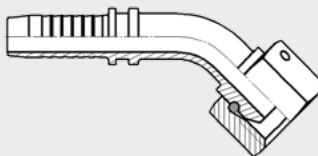

**DKR 90°
(BSPP Female 90°)**

Seite [page 52](#)

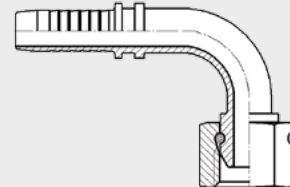

**DKRF
(BSPP Female Flat Seal)**

Seite [page 53](#)

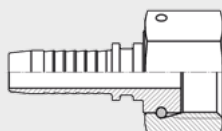

**DKRF 90°
(BSPP Female Flat Seal 90°)**

Seite [page 54](#)

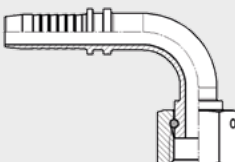

**AGJ
(JIC)**

Seite [page 55](#)

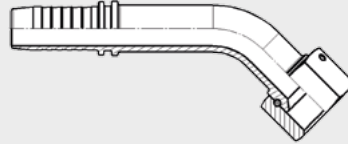
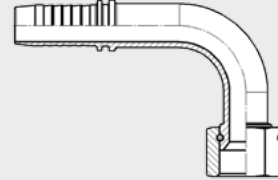
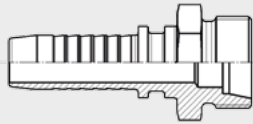
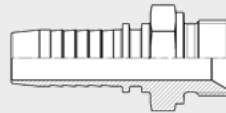
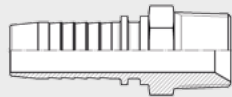
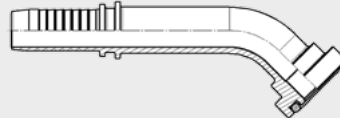
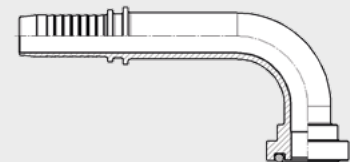
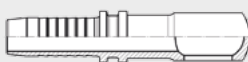
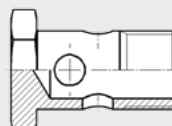

Übersicht Visual Index**DKJ**
(JIC Female)Seite [page 56](#)**DKJ 45°**
(JIC Female 45°)Seite [page 57](#)**DKJ 90°**
(JIC Female 90°)Seite [page 58](#)**CE**
(Metric Male)Seite [page 59](#)**AGR**
(BSPP)Seite [page 60](#)**AGR WD**
(BSPP WD)Seite [page 61](#)**AGR BSPT-m**
(BSPT Male)Seite [page 62](#)**AGN**
(NPT)Seite [page 63](#)**DSN**
(Hose Connector)Seite [page 64](#)**SFL3 / SFS6**
(Code 61 / 62)Seite [page 65](#)**SFL3 / SFS6 45°**
(Code 61 / 62 45°)Seite [page 66](#)**SFL3 / SFS6 90°**
(Code 61 / 62 90°)Seite [page 67](#)**RGN**
(Banjo Hosetail)Seite [page 68](#)**HSCH**
(Banjo Bolt)Seite [page 69](#)**DKO KÄ**
(Water Blaster)Seite [page 70](#)

DKO

- Gerader Nippel
- mit 24° DKO-Dichtkegel und O-Ring Viton
- L- und S-Reihe
- Gewinde: Metrisch-zyl.

- Straight Female Hose Tail
- with 24° Sealing Cone and Viton O-Ring
- L and S Series
- Thread: Metric Parallel

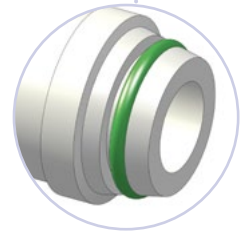
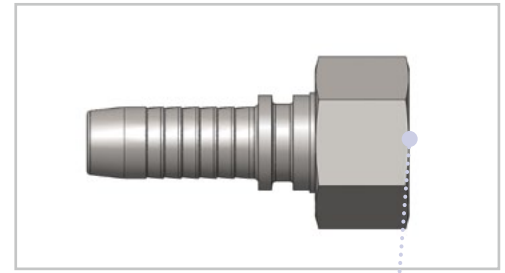
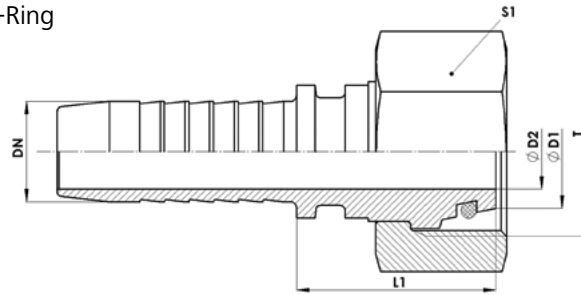

DKO									
Baureihe Series	Schlauch Hose		T	D1 mm	D2 mm	L1 mm	S1 mm	Bezeichnung Description	Artikel-Nr. Article No.
	DN	Ø inch							
L	5	3/16"	M 12 x 1,5	6	2,5	24	17	DKO 06L DN 05	209188
	5	3/16"	M 14 x 1,5	8	2,5	21	17	DKO 08L DN 05	222317
	6	1/4"	M 12 x 1,5	6	2,5	22	17	DKO 06L DN 06	200905
	6	1/4"	M 14 x 1,5	8	4	24	17	DKO 08L DN 06	200639
	6	1/4"	M 16 x 1,5	10	4,5	24	19	DKO 10L DN 06	201925
	6	1/4"	M 18 x 1,5	12	4,5	24	22	DKO 12L DN 06	222201
	8	5/16"	M 14 x 1,5	8	5,5	22	17	DKO 08L DN 08	222202
	8	5/16"	M 16 x 1,5	10	5,5	24	19	DKO 10L DN 08	200626
	8	5/16"	M 18 x 1,5	12	5,5	24	22	DKO 12L DN 08	201137
	10	3/8"	M 16 x 1,5	10	7,1	23	19	DKO 10L DN 10	200977
	10	3/8"	M 18 x 1,5	12	7,1	24	22	DKO 12L DN 10	200593
	10	3/8"	M 22 x 1,5	15	7,1	25	27	DKO 15L DN 10	201575
	12	1/2"	M 22 x 1,5	15	9,7	26	27	DKO 15L DN 12	200600
	12	1/2"	M 26 x 1,5	18	9,7	25	32	DKO 18L DN 12	218013
	16	5/8"	M 26 x 1,5	18	13	27	32	DKO 18L DN 16	200649
	16	5/8"	M 30 x 2	22	13	28	36	DKO 22L DN 16	219257
	20	3/4"	M 30 x 2	22	15,4	28	36	DKO 22L DN 20	200652
	20	3/4"	M 36 x 2	28	15,4	29	41	DKO 28L DN 20	222203
	25	1"	M 36 x 2	28	21,4	30	41	DKO 28L DN 25	200906
	32	1.1/4"	M 45 x 2	35	27	33	50	DKO 35L DN 32	200630
40	1.1/2"	M 52 x 2	42	33,3	33	60	DKO 42L DN 40	201577	
S	6	1/4"	M 14 x 1,5	6	3	23	17	DKO 06S DN 06	202809
	6	1/4"	M 16 x 1,5	8	4	24	19	DKO 08S DN 06	200875
	6	1/4"	M 18 x 1,5	10	4,5	25	22	DKO 10S DN 06	201852
	6	1/4"	M 20 x 1,5	12	4,5	25	24	DKO 12S DN 06	222204
	8	5/16"	M 18 x 1,5	10	5,5	23	22	DKO 10S DN 08	208772
	8	5/16"	M 20 x 1,5	12	5,5	25	24	DKO 12S DN 08	201422
	10	3/8"	M 18 x 1,5	10	7,1	24	22	DKO 10S DN 10	215452
	10	3/8"	M 20 x 1,5	12	7,1	26	24	DKO 12S DN 10	200628
	10	3/8"	M 22 x 1,5	14	7,1	28	27	DKO 14S DN 10	201574
	10	3/8"	M 24 x 1,5	16	7,1	26	30	DKO 16S DN 10	212216
	12	1/2"	M 20 x 1,5	12	9,7	24	24	DKO 12S DN 12	206975
	12	1/2"	M 24 x 1,5	16	9,7	27	30	DKO 16S DN 12	201854
	16	5/8"	M 30 x 2	20	13	31	36	DKO 20S DN 16	200876
	20	3/4"	M 30 x 2	20	15,4	29	36	DKO 20S DN 20	206976
	20	3/4"	M 36 x 2	25	15,4	32	46	DKO 25S DN 20	201410
	20	3/4"	M 42 x 2	30	15,4	30	50	DKO 30S DN 20	218803
	25	1"	M 36 x 2	25	21,4	34	46	DKO 25S DN 25	200878
	25	1"	M 42 x 2	30	21,4	34	50	DKO 30S DN 25	201112
	32	1.1/4"	M 52 x 2	38	27	36	60	DKO 38S DN 32	201576

DKO 45°

- Nippel 45°-Bogen
- mit 24° DKO-Dichtkegel und O-Ring Viton
- L- und S-Reihe
- Gewinde: Metrisch-zyl.

- Female 45° Swept Bend Hose Tail
- with 24° Sealing Cone and Viton O-Ring
- L and S Series
- Thread: Metric Parallel

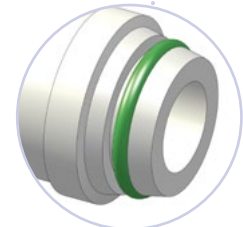
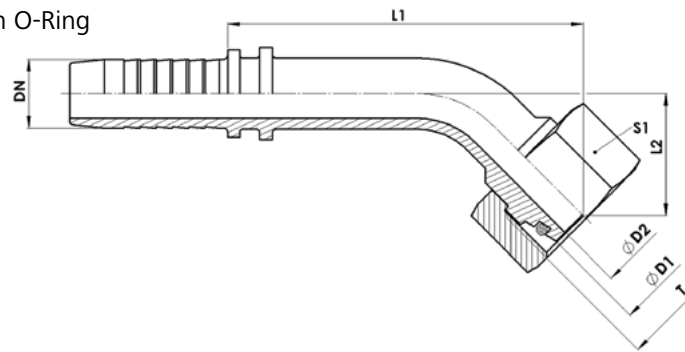
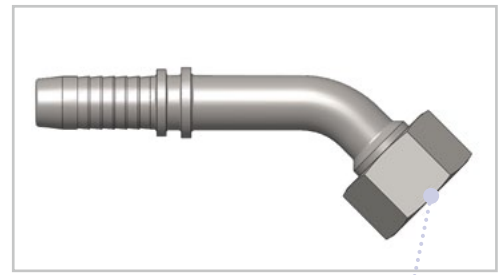

DKO 45°										
Baureihe Series	Schlauch Hose		T	D1	D2	L1*	L2*	S1	Bezeichnung Description	Artikel-Nr. Article No.
	DN	Ø inch		mm	mm	mm	mm	mm		
L	6	1/4"	M 12 x 1,5	6	2,5	38	17	17	DKO 06L DN 06 45°	207989
	6	1/4"	M 14 x 1,5	8	4	41	20	17	DKO 08L DN 06 45°	200686
	6	1/4"	M 16 x 1,5	10	4,5	44	23	19	DKO 10L DN 06 45°	208001
	6	1/4"	M 18 x 1,5	12	4,5	42	22	22	DKO 12L DN 06 45°	222205
	8	5/16"	M 16 x 1,5	10	5,5	45	21	19	DKO 10L DN 08 45°	200655
	8	5/16"	M 18 x 1,5	12	5,5	47	23	22	DKO 12L DN 08 45°	202334
	10	3/8"	M 16 x 1,5	10	7,1	46	19	19	DKO 10L DN 10 45°	207972
	10	3/8"	M 18 x 1,5	12	7,1	49	22	22	DKO 12L DN 10 45°	202335
	10	3/8"	M 22 x 1,5	15	7,1	52	25	27	DKO 15L DN 10 45°	202339
	12	1/2"	M 22 x 1,5	15	9,7	56	24	27	DKO 15L DN 12 45°	202340
	16	5/8"	M 26 x 1,5	18	13	67	27	32	DKO 18L DN 16 45°	202342
	20	3/4"	M 30 x 2	22	15,4	72	29	36	DKO 22L DN 20 45°	202344
	25	1"	M 36 x 2	28	21,4	87	34	41	DKO 28L DN 25 45°	202347
	32	1.1/4"	M 45 x 2	35	27	104	41	50	DKO 35L DN 32 45°	202349
40	1.1/2"	M 52 x 2	42	33,3	117	43	60	DKO 42L DN 40 45°	207974	
S	6	1/4"	M 14 x 1,5	6	3	42	21	17	DKO 06S DN 06 45°	207975
	6	1/4"	M 16 x 1,5	8	4	41	20	19	DKO 08S DN 06 45°	200877
	6	1/4"	M 18 x 1,5	10	4,5	44	22,5	22	DKO 10S DN 06 45°	207977
	6	1/4"	M 20 x 1,5	12	5,5	43	24	24	DKO 12S DN 06 45°	222206
	8	5/16"	M 20 x 1,5	12	5,5	48	24	24	DKO 12S DN 08 45°	202902
	10	3/8"	M 18 x 1,5	10	7,1	50	23	22	DKO 10S DN 10 45°	222425
	10	3/8"	M 20 x 1,5	12	7,1	50	23	24	DKO 12S DN 10 45°	202337
	10	3/8"	M 22 x 1,5	14	7,1	51	24	27	DKO 14S DN 10 45°	202338
	10	3/8"	M 24 x 1,5	16	7,1	53	26	30	DKO 16S DN 10 45°	207979
	12	1/2"	M 24 x 1,5	16	9,7	56	24	30	DKO 16S DN 12 45°	201457
	12	1/2"	M 30 x 1,5	20	13	57	27	36	DKO 20S DN 12 45°	222207
	16	5/8"	M 30 x 2	20	13	71	32	36	DKO 20S DN 16 45°	201491
	20	3/4"	M 30 x 2	20	15,4	73	32	36	DKO 20S DN 20 45°	222426
	20	3/4"	M 36 x 2	25	15,4	75	32	46	DKO 25S DN 20 45°	201115
	25	1"	M 36 x 2	25	21,4	87	34	46	DKO 25S DN 25 45°	200820
	25	1"	M 42 x 2	30	21,4	89	37	50	DKO 30S DN 25 45°	202348
32	1.1/4"	M 52 x 2	38	27	106	43	60	DKO 38S DN 32 45°	202350	

* Werte können abweichend sein / Values may differ

DKO 90°

- Nippel 90°-Bogen
- mit 24° DKO-Dichtkegel und O-Ring Viton
- L- und S-Reihe
- Gewinde: Metrisch-zyl.

- Female 90° Swept Bend Hose Tail
- with 24° Sealing Cone and Viton O-Ring
- L and S Series
- Thread: Metric Parallel

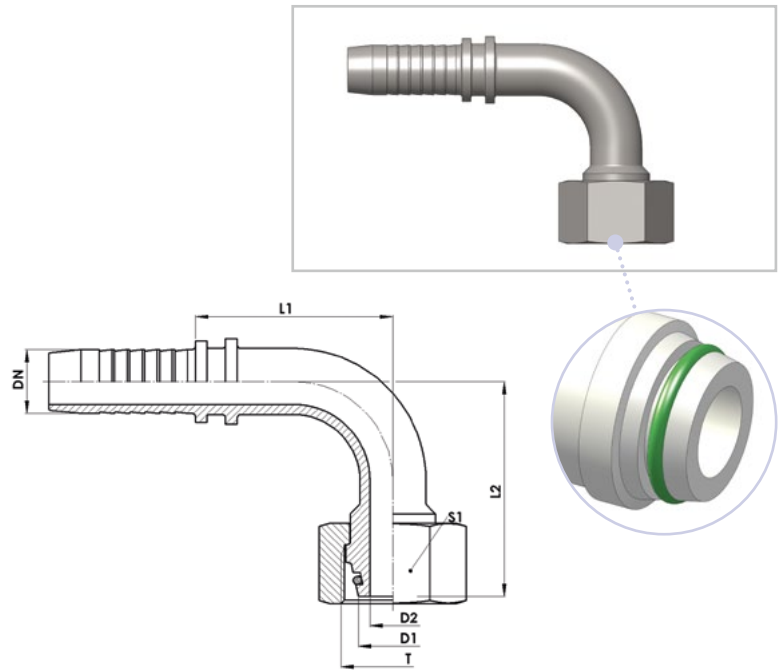

DKO 90°

Baureihe Series	Schlauch Hose		T	D1	D2	L1*	L2*	S1	Bezeichnung Description	Artikel-Nr. Article no.
	DN	Ø inch								
L	6	1/4"	M 12 x 1,5	6	2,5	31	31	17	DKO 06L DN 06 90°	207980
	6	1/4"	M 14 x 1,5	8	4	31	35	17	DKO 08L DN 06 90°	207969
	6	1/4"	M 16 x 1,5	10	4,5	31	39	19	DKO 10L DN 06 90°	207981
	8	5/16"	M 16 x 1,5	10	5,5	34	42	19	DKO 10L DN 08 90°	200654
	8	5/16"	M 18 x 1,5	12	5,5	34	41	22	DKO 12L DN 08 90°	207982
	10	3/8"	M 16 x 1,5	10	7,1	39	37	19	DKO 10L DN 10 90°	207984
	10	3/8"	M 18 x 1,5	12	7,1	39	40	22	DKO 12L DN 10 90°	200657
	10	3/8"	M 22 x 1,5	15	7,1	39	44	27	DKO 15L DN 10 90°	207973
	12	1/2"	M 22 x 1,5	15	9,7	42	46	27	DKO 15L DN 12 90°	200659
	16	5/8"	M 26 x 1,5	18	13	50	55	32	DKO 18L DN 16 90°	201094
	20	3/4"	M 30 x 2	22	15,4	62	60	36	DKO 22L DN 20 90°	207976
	25	1"	M 36 x 2	28	21,4	83	73	41	DKO 28L DN 25 90°	200597
	32	1.1/4"	M 45 x 2	35	27	92	88	50	DKO 35L DN 32 90°	207978
40	1.1/2"	M 52 x 2	42	33,3	102	97	60	DKO 42L DN 40 90°	202003	
S	6	1/4"	M 14 x 1,5	6	3	31	37	17	DKO 06S DN 06 90°	207983
	6	1/4"	M 16 x 1,5	8	4	31	35	19	DKO 08S DN 06 90°	207985
	6	1/4"	M 18 x 1,5	10	4,5	31	39	22	DKO 10S DN 06 90°	201831
	8	5/16"	M 20 x 1,5	12	5,5	34	42	24	DKO 12S DN 08 90°	202336
	10	3/8"	M 18 x 1,5	10	6	39	41	22	DKO 10S DN 10 90°	215604
	10	3/8"	M 20 x 1,5	12	7,1	39	42	24	DKO 12S DN 10 90°	201026
	10	3/8"	M 22 x 1,5	14	7,1	39	44	27	DKO 14S DN 10 90°	201517
	10	3/8"	M 24 x 1,5	16	7,1	39	42	30	DKO 16S DN 10 90°	208469
	12	1/2"	M 24 x 1,5	16	9,7	42	46	30	DKO 16S DN 12 90°	200624
	12	1/2"	M 30 x 2	20	9,7	42	59	36	DKO 20S DN 12 90°	222208
	16	5/8"	M 30 x 2	20	13	50	61	36	DKO 20S DN 16 90°	202343
	20	3/4"	M 30 x 2	20	15,4	62	62	36	DKO 20S DN 20 90°	209287
	20	3/4"	M 36 x 2	25	15,4	62	64	46	DKO 25S DN 20 90°	202345
	25	1"	M 36 x 2	25	21,4	83	78	46	DKO 25S DN 25 90°	202346
	25	1"	M 42 x 2	30	21,4	83	76	50	DKO 30S DN 25 90°	201113
32	1.1/4"	M 52 x 2	38	27	92	90	60	DKO 38S DN 32 90°	207986	

* Werte können abweichend sein / Values may differ

DKLL / DKL / DKS

- Gerader Nippel
- mit Universaldichtkegel
- L- und S-Reihe
- Gewinde: Metrisch-zykl.

- Straight Female Hose Tail
- with Universal-Swivel
- L and S Series
- Thread: Metric Parallel

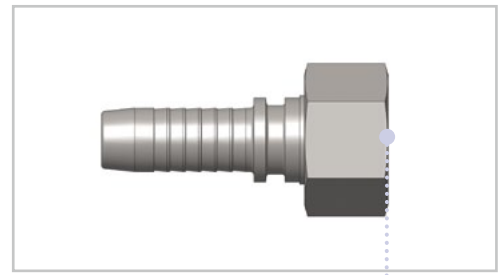
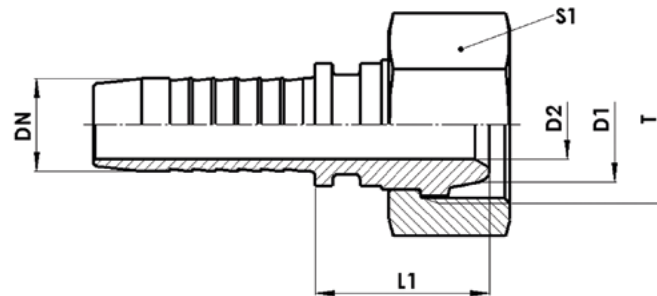

DKLL / DKL / DKS

Baureihe Series	Schlauch Hose		T	D1 mm	D2 mm	L1 mm	S1 mm	Bezeichnung Description	Artikel-Nr. Article no.
	DN	Ø inch							
LL	20	3/4"	M 30 x 1,5		15,4	27	36	DKLL M30x1,5 DN 20	203308
	25	1"	M 38 x 1,5		21,4	29	46	DKLL M38x1,5 DN 25	201850
	32	1.1/4"	M 45 x 1,5		27	33	55	DKLL M45x1,5 DN 32	208151
	40	1.1/2"	M 52 x 1,5		33,3	33	60	DKLL M52x1,5 DN 40	208152
	50	2"	M 65 x 2		40	38	70	DKLL M65x2 DN 50	208153
	60	3"	M 78 x 2		52	40	90	DKLL M78x2 DN 60	208154
L	5	3/16"	M 12 x 1,5	6	2,7	20	17	DKL 06L DN 05	222361
	6	1/4"	M 12 x 1,5	6	4,5	26	17	DKL 06L DN 06	206972
	6	1/4"	M 14 x 1,5	8	4,5	23	17	DKL 08L DN 06	201601
	6	1/4"	M 16 x 1,5	10	4,5	23	19	DKL 10L DN 06	206973
	6	1/4"	M 18 x 1,5	12	4,5	23	22	DKL 12L DN 06	208155
	8	5/16"	M 16 x 1,5	10	5,5	22	19	DKL 10L DN 08	201583
	8	5/16"	M 18 x 1,5	12	5,5	23	22	DKL 12L DN 08	201585
	10	3/8"	M 16 x 1,5	10	7	25	19	DKL 10L DN 10	206945
	10	3/8"	M 18 x 1,5	12	7	22	22	DKL 12L DN 10	201587
	10	3/8"	M 22 x 1,5	15	7	23	27	DKL 15L DN 10	201589
	12	1/2"	M 22 x 1,5	15	9,5	25	27	DKL 15L DN 12	201581
	16	5/8"	M 26 x 1,5	18	13	25	32	DKL 18L DN 16	201591
	20	3/4"	M 30 x 2	22	15,5	27	36	DKL 22L DN 20	201593
	25	1"	M 36 x 2	28	21,5	29	41	DKL 28L DN 25	201595
32	1.1/4"	M 45 x 2	35	27	30	50	DKL 35L DN 32	201597	
40	1.1/2"	M 52 x 2	42	33,5	30	60	DKL 42L DN 40	201599	
S	6	1/4"	M 18 x 1,5	10	4,5	24	22	DKS 10S DN 06	202309
	8	5/16"	M 20 x 1,5	12	5,5	24	24	DKS 12S DN 08	201604
	10	3/8"	M 20 x 1,5	12	7	24	24	DKS 12S DN 10	201606
	10	3/8"	M 22 x 1,5	14	7	26	27	DKS 14S DN 10	201608
	12	1/2"	M 24 x 1,5	16	9,5	26	30	DKS 16S DN 12	201613
	16	5/8"	M 30 x 2	20	13	28	36	DKS 20S DN 16	201615
	20	3/4"	M 36 x 2	25	15,5	30	46	DKS 25S DN 20	201617
	25	1"	M 36 x 2	25	21,5	31	46	DKS 25S DN 25	201619
	25	1"	M 42 x 2	30	21,5	31	50	DKS 30S DN 25	201621
	32	1.1/4"	M 52 x 2	38	27	33	60	DKS 38S DN 32	201623

DKLL / DKL / DKS 45°

- Nippel 45°-Bogen
- mit Universaldichtkegel
- L- und S-Reihe
- Gewinde: Metrisch-zyl.

- Female 45° Swept Bend Hose Tail
- with Universal-Swivel
- L and S Series
- Thread: Metric Parallel

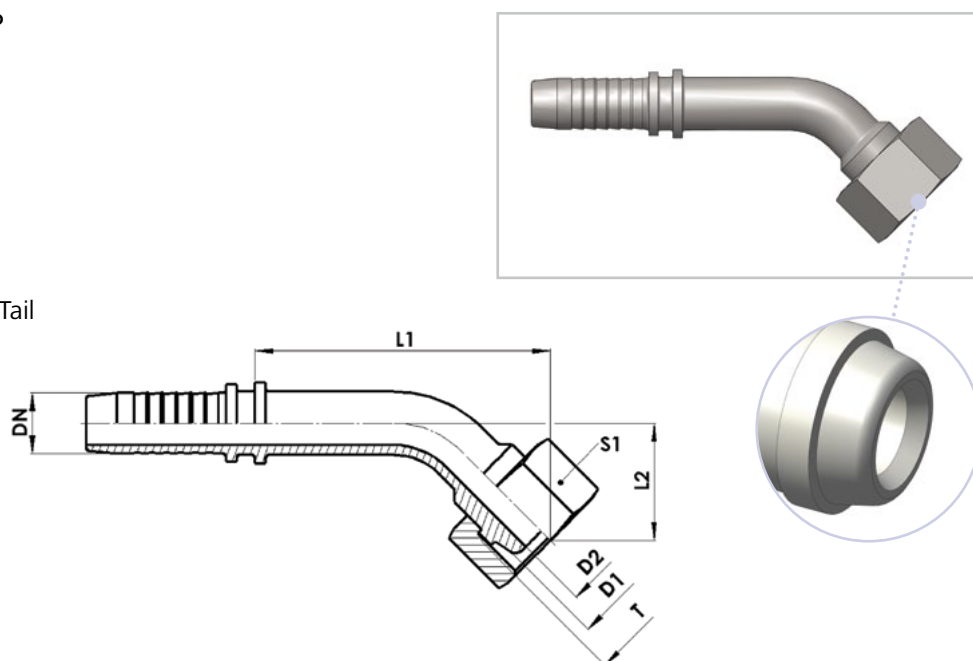

DKLL / DKL / DKS 45°

Baureihe Series	Schlauch Hose		T mm	D1 mm	D2 mm	L1* mm	L2* mm	S1 mm	Bezeichnung Description	Artikel-Nr. Article no.
	DN	Ø inch								
LL	20	3/4"	M 30 x 1,5		15,4	70	30	36	DKLL M30x1,5 DN 20 45°	208133
	25	1"	M 38 x 1,5		21,4	71	37	46	DKLL M38x1,5 DN 25 45°	208134
	32	1.1/4"	M 45 x 1,5		27	97	41	55	DKLL M45x1,5 DN 32 45°	208135
	40	1.1/2"	M 52 x 1,5		33,3	120	52	60	DKLL M52x1,5 DN 40 45°	208136
	50	2"	M 65 x 2		40	145	52	75	DKLL M65x2 DN 50 45°	208137
	60	3"	M 78 x 2		52	170	65	90	DKLL M78x2 DN 60 45°	208138
L	6	1/4"	M 12 x 1,5	6	4,5	38	17	17	DKL 06L DN 06 45°	208053
	6	1/4"	M 14 x 1,5	8	4,5	41	21	17	DKL 08L DN 06 45°	208056
	6	1/4"	M 16 x 1,5	10	4,5	40	20	19	DKL 10L DN 06 45°	208057
	6	1/4"	M 18 x 1,5	12	4,5	41	21	22	DKL 12L DN 06 45°	208058
	8	5/16"	M 16 x 1,5	10	5,5	44	21	19	DKL 10L DN 08 45°	208059
	8	5/16"	M 18 x 1,5	12	5,5	45	21	22	DKL 12L DN 08 45°	208060
	10	3/8"	M 16 x 1,5	10	7	46	20	19	DKL 10L DN 10 45°	208061
	10	3/8"	M 18 x 1,5	12	7	48	22	22	DKL 12L DN 10 45°	208062
	10	3/8"	M 22 x 1,5	15	7	50	23	27	DKL 15L DN 10 45°	208063
	12	1/2"	M 22 x 1,5	15	9,5	55	24	27	DKL 15L DN 12 45°	208064
	16	5/8"	M 26 x 1,5	18	13	66	28	32	DKL 18L DN 16 45°	208069
	20	3/4"	M 30 x 2	22	15,5	70	28	36	DKL 22L DN 20 45°	208112
	25	1"	M 36 x 2	28	21,5	86	34	41	DKL 28L DN 25 45°	208113
	32	1.1/4"	M 45 x 2	35	27	100	39	50	DKL 35L DN 32 45°	208114
40	1.1/2"	M 52 x 2	42	33,5	114	41	60	DKL 42L DN 40 45°	208115	
S	6	1/4"	M 18 x 1,5	10	4,5	42	22	22	DKS 10S DN 06 45°	208116
	8	5/16"	M 20 x 1,5	12	5,5	46	22	24	DKS 12S DN 08 45°	208118
	10	3/8"	M 20 x 1,5	12	7	49	23	24	DKS 12S DN 10 45°	208119
	10	3/8"	M 22 x 1,5	14	7	51	25	27	DKS 14S DN 10 45°	208120
	12	1/2"	M 24 x 1,5	16	9,5	56	25	30	DKS 16S DN 12 45°	208121
	16	5/8"	M 30 x 2	20	13	66	28	36	DKS 20S DN 16 45°	208122
	20	3/4"	M 36 x 2	25	15,5	72	31	46	DKS 25S DN 20 45°	208123
	25	1"	M 36 x 2	25	21,5	87	36	46	DKS 25S DN 25 45°	208124
	25	1"	M 42 x 2	30	21,5	87	36	50	DKS 30S DN 25 45°	208125
	32	1.1/4"	M 52 x 2	38	27	103	41	60	DKS 38S DN 32 45°	208126

* Werte können abweichend sein / Values may differ

DKLL / DKL / DKS 90°

- Nippel 90°-Bogen
- mit Universaldichtkegel
- L- und S-Reihe
- Gewinde: Metrisch-zyl.

- Female 90° Swept Bend Hose Tail
- with Universal-Swivel
- L and S Series
- Thread: Metric Parallel

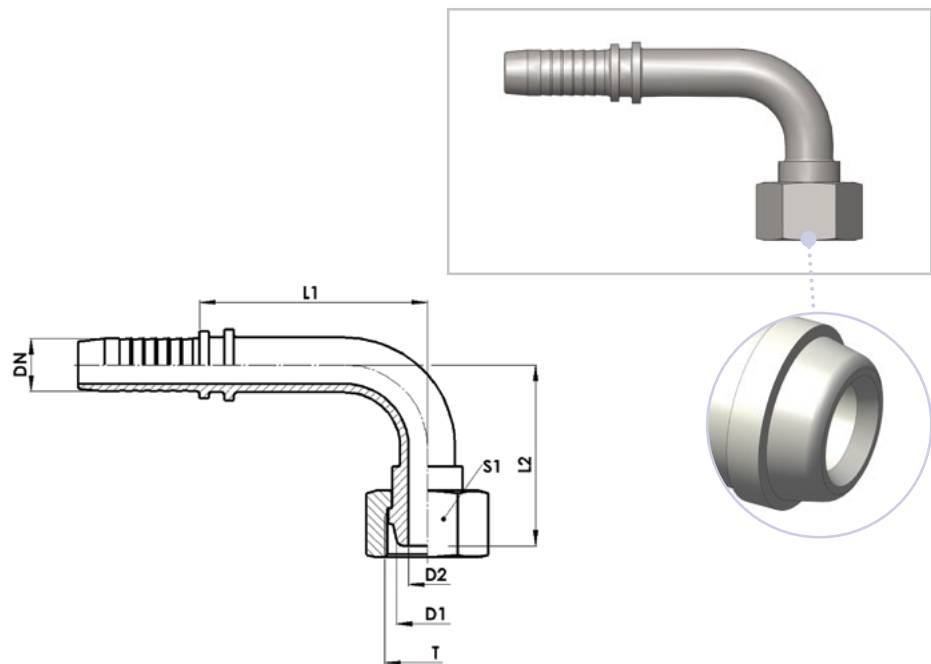

DKLL / DKL / DKS 90°

Baureihe Series	Schlauch Hose	T	D1	D2	L1*	L2*	S1	Bezeichnung Description	Artikel-Nr. Article no.	
	DN Ø inch	mm	mm	mm	mm	mm	mm			
LL	20	3/4"	M 30 x 1,5		15,4	64	62	36	DKLL M30x1,5 DN 20 90°	208139
	25	1"	M 38 x 1,5		21,4	68	77	46	DKLL M38x1,5 DN 25 90°	203159
	32	1.1/4"	M 45 x 1,5		27	94	87	55	DKLL M45x1,5 DN 32 90°	208140
	40	1.1/2"	M 52 x 1,5		33,3	108	107	60	DKLL M52x1,5 DN 40 90°	208141
	50	2"	M 65 x 2		40	126	128	75	DKLL M65x2 DN 50 90°	208142
	60	3"	M 78 x 2		52	150	155	90	DKLL M78x2 DN 60 90°	208143
L	6	1/4"	M 12 x 1,5	6	4,5	32	35	17	DKL 06L DN 06 90°	208146
	6	1/4"	M 14 x 1,5	8	4,5	32	36	17	DKL 08L DN 06 90°	202310
	6	1/4"	M 16 x 1,5	10	4,5	32	37	19	DKL 10L DN 06 90°	208147
	6	1/4"	M 18 x 1,5	12	4,5	32	38	22	DKL 12L DN 06 90°	208148
	8	5/16"	M 16 x 1,5	10	5,5	35	35	19	DKL 10L DN 08 90°	202312
	8	5/16"	M 18 x 1,5	12	5,5	35	39	22	DKL 12L DN 08 90°	202314
	10	3/8"	M 16 x 1,5	10	7	39	38	19	DKL 10L DN 10 90°	208149
	10	3/8"	M 18 x 1,5	12	7	39	40	22	DKL 12L DN 10 90°	202315
	10	3/8"	M 22 x 1,5	15	7	39	43	27	DKL 15L DN 10 90°	202319
	12	1/2"	M 22 x 1,5	15	9,5	43	46	27	DKL 15L DN 12 90°	202320
	16	5/8"	M 26 x 1,5	18	13	50	55	32	DKL 18L DN 16 90°	202322
	20	3/4"	M 30 x 2	22	15,5	67	59	36	DKL 22L DN 20 90°	202323
	25	1"	M 36 x 2	28	21,5	83	73	41	DKL 28L DN 25 90°	202326
	32	1.1/4"	M 45 x 2	35	27	97	85	50	DKL 35L DN 32 90°	202328
40	1.1/2"	M 52 x 2	42	33,5	102	95	60	DKL 42L DN 40 90°	202330	
S	6	1/4"	M 18 x 1,5	10	4,5	32	37	22	DKS 10S DN 06 90°	202313
	8	5/16"	M 20 x 1,5	12	5,5	35	41	24	DKS 12S DN 08 90°	202316
	10	3/8"	M 20 x 1,5	12	7	39	42	24	DKS 12S DN 10 90°	202317
	10	3/8"	M 22 x 1,5	14	7	39	45	27	DKS 14S DN 10 90°	202318
	12	1/2"	M 24 x 1,5	16	9,5	43	47	30	DKS 16S DN 12 90°	202321
	16	5/8"	M 30 x 2	20	13	50	56	36	DKS 20S DN 16 90°	208150
	20	3/4"	M 36 x 2	25	15,5	57	62	46	DKS 25S DN 20 90°	202324
	25	1"	M 36 x 2	25	21,5	83	75	46	DKS 25S DN 25 90°	202325
	25	1"	M 42 x 2	30	21,5	83	75	50	DKS 30S DN 25 90°	202327
32	1.1/4"	M 52 x 2	38	27	94	88	60	DKS 38S DN 32 90°	202329	

* Werte können abweichend sein / Values may differ

BE (Metric Standpipe)

- Gerader Nippel mit Rohrstützen
- L- und S-Reihe
- für 24°-Schneidringverschraubung

- Metric Standpipe Hose Tail
- L and S Series
- for 24° Cutting Ring Coupling

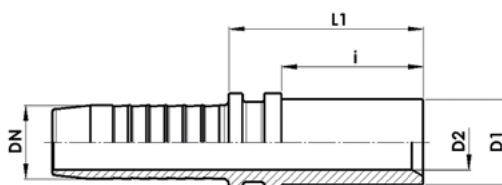
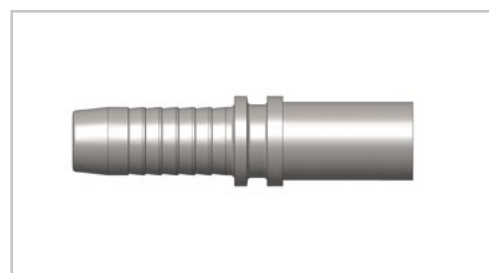

BE (Metric Standpipe)									
Baureihe Series	Schlauch Hose	D1	D2	L1	i	Bezeichnung Description	Artikel-Nr. Article No.		
	DN Ø inch	mm	mm	mm	mm				
L	5 3/16"	6	2,7	27	20	BE 06L DN 05	222372		
	5 3/16"	8	2,7	29	22	BE 08L DN 05	222373		
	6 1/4"	6	4,5	28	20	BE 06L DN 06	200661		
	6 1/4"	8	4,5	30	22	BE 08L DN 06	200662		
	6 1/4"	10	4,5	32	24	BE 10L DN 06	201397		
	8 5/16"	8	5,5	28	22	BE 08L DN 08	201758		
	8 5/16"	10	5,5	32	24	BE 10L DN 08	200663		
	8 5/16"	12	5,5	33	25	BE 12L DN 08	201756		
	10 3/8"	10	7,1	33	24	BE 10L DN 10	201462		
	10 3/8"	12	7,1	34	25	BE 12L DN 10	200664		
	10 3/8"	15	7,1	32	25	BE 15L DN 10	201760		
	12 1/2"	12	9,7	34	25	BE 12L DN 12	201554		
	12 1/2"	15	9,7	34	25	BE 15L DN 12	200909		
	12 1/2"	18	9,7	34	25	BE 18L DN 12	222374		
	16 5/8"	18	13	34	25	BE 18L DN 16	200980		
	16 5/8"	22	13	34	25	BE 22L DN 16	222375		
	20 3/4"	22	15,4	35	25	BE 22L DN 20	200665		
25 1"	Wir empfehlen DKO oder DKL / We recommend DKO or DKL					BE 28L DN 25	201764		
32 1.1/4"	Wir empfehlen DKO oder DKL / We recommend DKO or DKL					BE 35L DN 32	201766		
40 1.1/2"	Wir empfehlen DKO oder DKL / We recommend DKO or DKL					BE 42L DN 40	208230		
S	5 3/16"	6	2,7	27	20	BE 06S DN 05	222376		
	6 1/4"	6	4,5	28	20	BE 06S DN 06	200661		
	6 1/4"	8	4,5	30	22	BE 08S DN 06	200662		
	6 1/4"	10	4,5	32	24	BE 10S DN 06	201397		
	6 1/4"	12	4,5	33	25	BE 12S DN 06	201757		
	8 5/16"	8	5,5	28	22	BE 08S DN 08	201758		
	8 5/16"	10	5,5	32	24	BE 10S DN 08	200663		
	8 5/16"	12	5,5	33	25	BE 12S DN 08	201756		
	10 3/8"	12	7,1	34	25	BE 12S DN 10	200664		
	10 3/8"	14	7,1	36	27	BE 14S DN 10	201759		
	12 1/2"	12	9,7	34	25	BE 12S DN 12	201554		
	12 1/2"	16	9,7	39	30	BE 16S DN 12	201119		
	12 1/2"	20	9,7	41	32	BE 20S DN 12	222377		
	16 5/8"	20	13	41	32	BE 20S DN 16	201761		
	20 3/4"	20	15,4	42	32	BE 20S DN 20	201762		
	25 3/4"	Wir empfehlen DKO oder DKL / We recommend DKO or DKL					BE 25S DN 20	201763	
	25 1"	Wir empfehlen DKO oder DKL / We recommend DKO or DKL					BE 30S DN 25	201765	
32 1.1/4"	Wir empfehlen DKO oder DKL / We recommend DKO or DKL					BE 38S DN 32	201767		

BE 45° (Metric Standpipe 45°)

- Nippel 45°-Bogen mit Rohrstützen
- L- und S-Reihe
- für 24°-Schneidringverschraubung

- Metric Standpipe 45° Swept Bend Hose Tail
- L and S Series
- for 24° Cutting Ring Coupling

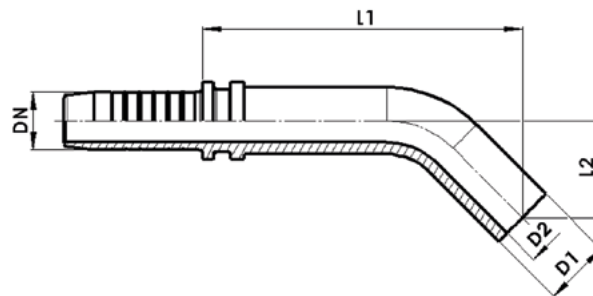
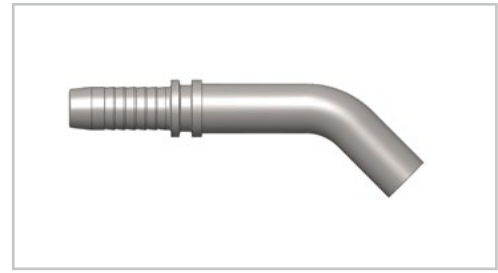

BE 45° (Metric Standpipe 45°)

Baureihe Series	Schlauch Hose		D1 mm	D2 mm	L1* mm	L2* mm	Bezeichnung Description	Artikel-Nr. Article No.
	DN	Ø inch						
L	6	1/4"	6	4,5	43	18	BE 06L DN 06 45°	208231
	6	1/4"	8	4,5	43	18	BE 08L DN 06 45°	208288
	6	1/4"	10	4,5	43	24	BE 10L DN 06 45°	208289
	8	5/16"	10	5,5	47	24	BE 10L DN 08 45°	208290
	8	5/16"	12	5,5	46	25	BE 12L DN 08 45°	208291
	10	3/8"	10	7,1	52	20	BE 10L DN 10 45°	208293
	10	3/8"	12	7,1	52	20	BE 12L DN 10 45°	208292
	12	1/2"	15	9,7	58	22	BE 15L DN 12 45°	208294
	16	5/8"	18	13	69	25	BE 18L DN 16 45°	208295
	20	3/4"	22	15,4	71	30	BE 22L DN 20 45°	208296
	25	1"	Wir empfehlen DKO oder DKL / We recommend DKO or DKL				BE 28L DN 25 45°	208297
	32	1.1/4"	Wir empfehlen DKO oder DKL / We recommend DKO or DKL				BE 35L DN 32 45°	208298
	40	1.1/2"	Wir empfehlen DKO oder DKL / We recommend DKO or DKL				BE 42L DN 40 45°	208299
S	6	1/4"	6	4,5	43	18	BE 06S DN 06 45°	208231
	6	1/4"	8	4,5	43	18	BE 08S DN 06 45°	208288
	6	1/4"	10	4,5	43	24	BE 10S DN 06 45°	208289
	8	5/16"	10	5,5	47	24	BE 10S DN 08 45°	208290
	8	5/16"	12	5,5	46	25	BE 12S DN 08 45°	208291
	10	3/8"	12	7,1	52	20	BE 12S DN 10 45°	208292
	10	3/8"	14	7,1	51	23	BE 14S DN 10 45°	208300
	12	1/2"	16	9,7	56	25	BE 16S DN 12 45°	208301
	16	5/8"	20	13	74	32	BE 20S DN 16 45°	208302
	20	3/4"	Wir empfehlen DKO oder DKL / We recommend DKO or DKL				BE 25S DN 20 45°	208303
	25	1"	Wir empfehlen DKO oder DKL / We recommend DKO or DKL				BE 30S DN 25 45°	208304
	32	1.1/4"	Wir empfehlen DKO oder DKL / We recommend DKO or DKL				BE 38S DN 32 45°	208305

* Werte können abweichend sein / Values may differ

BE 90° (Metric Standpipe 90°)

- Nippel 90°-Bogen mit Rohrstutzen
- L- und S-Reihe
- für 24°-Schneidringverschraubung

- Metric Standpipe 90° Swept Bend Hose Tail
- L and S Series
- for 24° Cutting Ring Coupling

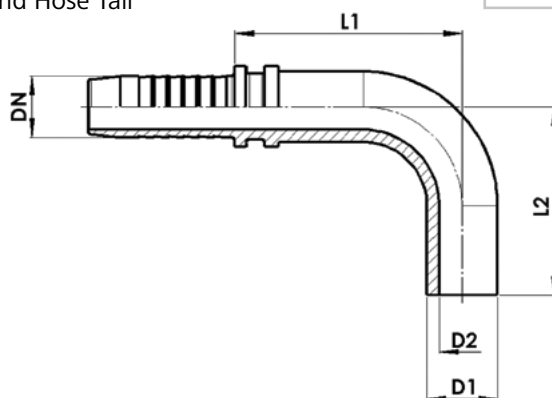
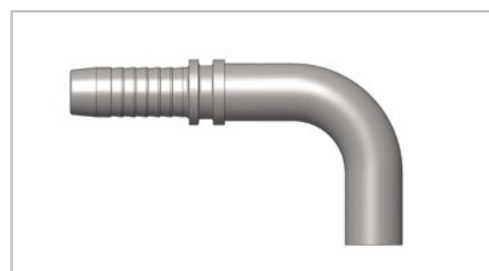
**BE 90° (Metric Standpipe 90°)**

Baureihe Series	Schlauch Hose		D1 mm	D2 mm	L1* mm	L2* mm	Bezeichnung Description	Artikel-Nr. Article No.
	DN	Ø inch						
L	6	1/4"	6	4,5	35	32	BE 06L DN 06 90°	208980
	6	1/4"	8	4,5	35	32	BE 08L DN 06 90°	208981
	6	1/4"	10	4,5	33	36	BE 10L DN 06 90°	208982
	8	5/16"	10	5,5	38	38	BE 10L DN 08 90°	208983
	8	5/16"	12	5,5	39	37	BE 12L DN 08 90°	208990
	10	3/8"	10	7,1	44	38	BE 10L DN 10 90°	208991
	10	3/8"	12	7,1	44	38	BE 12L DN 10 90°	208992
	12	1/2"	12	9,7	42	47	BE 12L DN 12 90°	201530
	12	1/2"	15	9,7	42	47	BE 15L DN 12 90°	208993
	16	5/8"	18	13	52	53	BE 18L DN 16 90°	208994
20	3/4"	22	15,4	68	63	BE 22L DN 20 90°	208995	
25	1"	Wir empfehlen DKO oder DKL / We recommend DKO or DKL				BE 28L DN 25 90°	208996	
32	1.1/4"	Wir empfehlen DKO oder DKL / We recommend DKO or DKL				BE 35L DN 32 90°	208997	
40	1.1/2"	Wir empfehlen DKO oder DKL / We recommend DKO or DKL				BE 42L DN 40 90°	208998	
S	6	1/4"	6	4,5	35	32	BE 06S DN 06 90°	208980
	6	1/4"	8	4,5	35	32	BE 08S DN 06 90°	208981
	6	1/4"	10	4,5	33	36	BE 10S DN 06 90°	208982
	8	5/16"	10	5,5	38	38	BE 10S DN 08 90°	208983
	8	5/16"	12	5,5	39	37	BE 12S DN 08 90°	208990
	10	3/8"	12	7,1	44	38	BE 12S DN 10 90°	208992
	10	3/8"	14	7,1	43	40	BE 14S DN 10 90°	209005
	12	1/2"	12	9,7	42	47	BE 12S DN 12 90°	201530
	12	1/2"	16	9,7	46	46	BE 16S DN 12 90°	209006
	16	5/8"	20	13	50	62	BE 20S DN 16 90°	209007
20	3/4"	Wir empfehlen DKO oder DKL / We recommend DKO or DKL				BE 25S DN 20 90°	209008	
25	1"	Wir empfehlen DKO oder DKL / We recommend DKO or DKL				BE 30S DN 25 90°	209009	
32	1.1/4"	Wir empfehlen DKO oder DKL / We recommend DKO or DKL				BE 38S DN 32 90°	209010	

* Werte können abweichend sein / Values may differ

DKR (BSPP Female)

- Gerader Nippel
- mit 60°-Dichtkegel
- Gewinde: BSPP

- BSPP Female Hose Tail
- with 60° Swivel
- Thread: BSPP

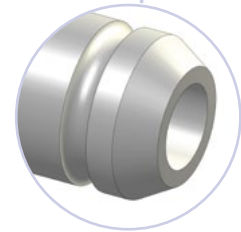
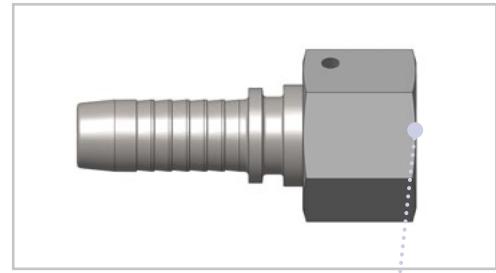
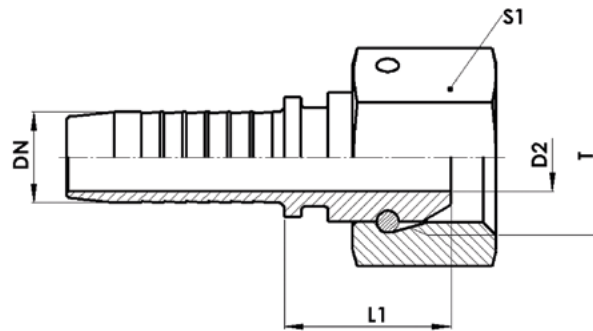

DKR (BSPP Female)

Schlauch Hose		T	D2	L1	S1	Bezeichnung Description	Artikel-Nr. Article No.
DN	Ø inch		mm	mm	mm		
6	1/4"	G 1/8"	4,5	17	14	DKR 1/8 DN 06	208170
6	1/4"	G 1/4"	4,5	21	17	DKR 1/4 DN 06	200667
6	1/4"	G 3/8"	4,5	21	22	DKR 3/8 DN 06	200642
8	5/16"	G 1/4"	5,5	21	17	DKR 1/4 DN 08	201999
8	5/16"	G 3/8"	5,5	21	22	DKR 3/8 DN 08	200951
8	5/16"	G 1/2"	5,5	22	27	DKR 1/2 DN 08	222209
10	3/8"	G 1/4"	5	21	17	DKR 1/4 DN 10	201494
10	3/8"	G 3/8"	7	21	22	DKR 3/8 DN 10	200952
10	3/8"	G 1/2"	7	23	27	DKR 1/2 DN 10	201495
12	1/2"	G 3/8"	10	22	22	DKR 3/8 DN 12	201496
12	1/2"	G 1/2"	10	24	27	DKR 1/2 DN 12	200645
12	1/2"	G 5/8"	10	23	30	DKR 5/8 DN 12	222210
12	1/2"	G 3/4"	10	25	32	DKR 3/4 DN 12	201498
16	5/8"	G 1/2"	13	23	27	DKR 1/2 DN 16	201499
16	5/8"	G 5/8"	13	20	30	DKR 5/8 DN 16	201500
16	5/8"	G 3/4"	13	24	32	DKR 3/4 DN 16	201501
20	3/4"	G 1/2"	15,5	24	27	DKR 1/2 DN 20	208171
20	3/4"	G 3/4"	15,5	25	32	DKR 3/4 DN 20	200619
20	3/4"	G 1"	15,5	25	41	DKR 1 DN 20	201342
25	1"	G 1"	21,5	26	41	DKR 1 DN 25	200669
25	1"	G 1.1/4"	21,5	29	50	DKR 1.1/4 DN 25	201502
32	1.1/4"	G 1.1/4"	27	30	50	DKR 1.1/4 DN 32	201504
32	1.1/4"	G 1.1/2"	27	31	55	DKR 1.1/2 DN 32	201503
40	1.1/2"	G 1.1/2"	33,5	32	55	DKR 1.1/2 DN 40	201140
50	2"	G 2"	40	37	70	DKR 2 DN 50	201505

DKR 45° (BSPP Female 45°)

- Nippel 45°-Bogen
- mit 60°-Dichtkegel
- Gewinde: BSPP

- BSPP Female 45° Swept Bend Hose Tail
- with 60° Swivel
- Thread: BSPP

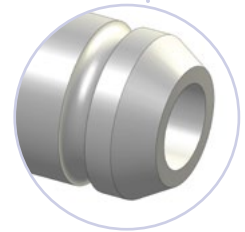
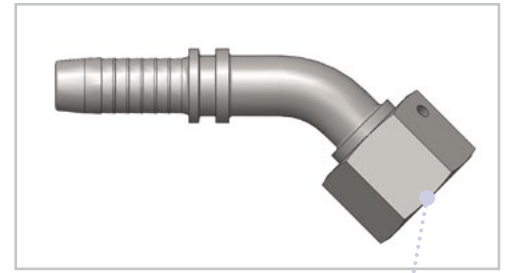
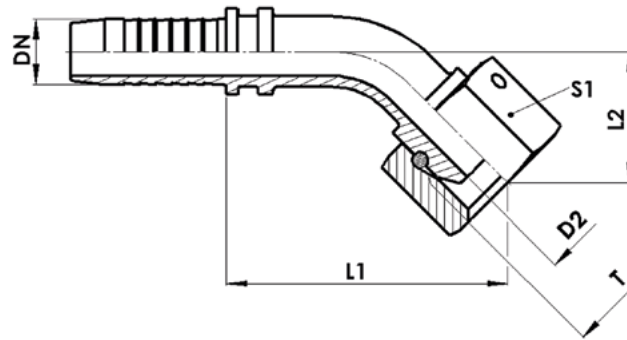

DKR 45° (BSPP Female 45°)

Schlauch Hose		T	D2	L1*	L2*	S1	Bezeichnung Description	Artikel-Nr. Article No.
DN	Ø inch		mm	mm	mm	mm		
6	1/4"	G 1/8"	4,5	38	17	14	DKR 1/8 DN 06 45°	208172
6	1/4"	G 1/4"	4,5	38	17	17	DKR 1/4 DN 06 45°	206794
6	1/4"	G 3/8"	4,5	39	18	22	DKR 3/8 DN 06 45°	208173
8	5/16"	G 1/4"	5,5	41	17	17	DKR 1/4 DN 08 45°	208175
8	5/16"	G 3/8"	5,5	42	19	22	DKR 3/8 DN 08 45°	202166
10	3/8"	G 1/4"	7	44	18	17	DKR 1/4 DN 10 45°	208176
10	3/8"	G 3/8"	7	45	19	22	DKR 3/8 DN 10 45°	208177
10	3/8"	G 1/2"	7	47	21	27	DKR 1/2 DN 10 45°	208178
12	1/2"	G 3/8"	10	53	22	22	DKR 3/8 DN 12 45°	208179
12	1/2"	G 1/2"	10	53	22	27	DKR 1/2 DN 12 45°	206792
12	1/2"	G 3/4"	10	56	24	32	DKR 3/4 DN 12 45°	206854
12	1/2"	G 5/8"	13	53	21	30	DKR 5/8 DN 12 45°	222211
16	5/8"	G 1/2"	13	62	23	27	DKR 1/2 DN 16 45°	208181
16	5/8"	G 3/4"	13	65	26	32	DKR 3/4 DN 16 45°	208182
16	5/8"	G 5/8"	13	62	24	30	DKR 5/8 DN 16 45°	224636
20	3/4"	G 1/2"	15,5	65	24	27	DKR 1/2 DN 20 45°	220183
20	3/4"	G 3/4"	15,5	67	25	32	DKR 3/4 DN 20 45°	206791
20	3/4"	G 1"	15,5	68	27	41	DKR 1 DN 20 45°	208184
25	1"	G 1"	21,5	82	30	41	DKR 1 DN 25 45°	208185
25	1"	G 1.1/4"	21,5	87	36	50	DKR 1.1/4 DN 25 45°	208187
32	1.1/4"	G 1.1/4"	27	99	37	50	DKR 1.1/4 DN 32 45°	208545
32	1.1/4"	G 1.1/2"	27	102	40	55	DKR 1.1/2 DN 32 45°	208188
40	1.1/2"	G 1.1/2"	33,5	114	40	55	DKR 1.1/2 DN 40 45°	208189
50	2"	G 2"	40	136	50	70	DKR 2 DN 50 45°	208190

* Werte können abweichend sein / Values may differ

DKR 90° (BSPP Female 90°)

- Nippel 90°-Bogen
- mit 60°-Dichtkegel
- Gewinde: BSPP

- BSPP Female 90° Swept Bend Hose Tail
- with 60° Swivel
- Thread: BSPP

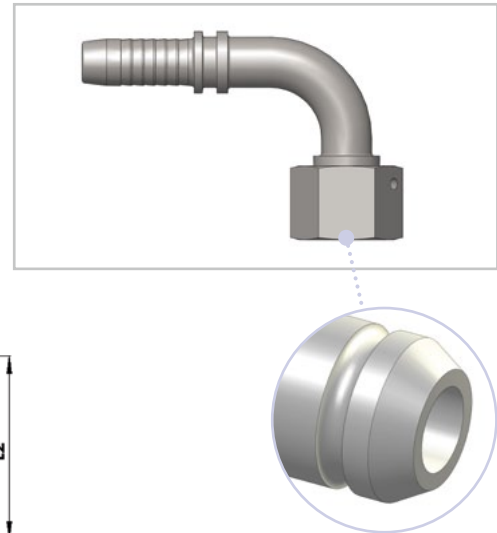
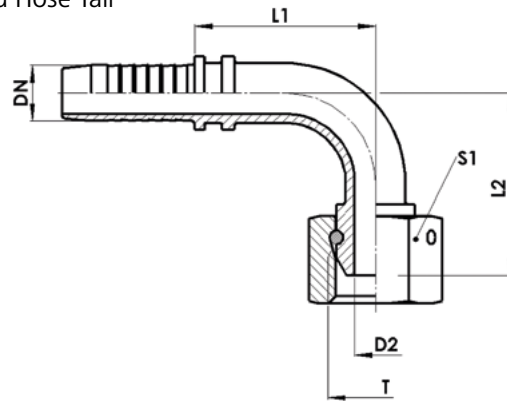

DKR 90° (BSPP Female 90°)

Baureihe Series	Schlauch Hose		T	D2	L1*	L2*	S1	Bezeichnung Description	Artikel-Nr. Article no.
	DN	Ø inch							
	6	1/4"	G 1/8" x	4,5	32	27	14	DKR 1/8 DN 06 90°	208174
	6	1/4"	G 1/4" x	4,5	32	31	17	DKR 1/4 DN 06 90°	206778
	6	1/4"	G 3/8" x	4,5	32	33	22	DKR 3/8 DN 06 90°	202164
	8	5/16"	G 1/4" x	5,5	35	33	17	DKR 1/4 DN 08 90°	202160
	8	5/16"	G 3/8" x	5,5	35	35	22	DKR 3/8 DN 08 90°	202168
	10	3/8"	G 1/4" x	7	39	35	17	DKR 1/4 DN 10 90°	202162
	10	3/8"	G 3/8" x	7	39	36	22	DKR 3/8 DN 10 90°	200997
	10	3/8"	G 1/2" x	7	39	39,5	27	DKR 1/2 DN 10 90°	202170
	12	1/2"	G 3/8" x	10	43	42,5	22	DKR 3/8 DN 12 90°	206853
	12	1/2"	G 1/2" x	10	43	43	27	DKR 1/2 DN 12 90°	201544
	12	1/2"	G 3/4" x	10	43	46,5	32	DKR 3/4 DN 12 90°	202211
	16	5/8"	G 1/2" x	13	50	48,5	27	DKR 1/2 DN 16 90°	202184
	16	5/8"	G 3/4" x	13	50	53	32	DKR 3/4 DN 16 90°	202283
	16	5/8"	G 5/8" x	13	50	62	30	DKR 5/8 DN 16 90°	202188
	20	3/4"	G 1/2" x	15,5	62	53	27	DKR 1/2 DN 20 90°	208192
	20	3/4"	G 3/4" x	15,5	62	54	32	DKR 3/4 DN 20 90°	202284
	20	3/4"	G 1" x	15,5	62	56	41	DKR 1 DN 20 90°	202285
	25	1"	G 1" x	21,5	83	67	41	DKR 1 DN 25 90°	202286
	25	1"	G 1.1/4" x	21,5	83	75	50	DKR 1.1/4 DN 25 90°	202287
	32	1.1/4"	G 1.1/4" x	27	92	86	50	DKR 1.1/4 DN 32 90°	202288
	32	1.1/4"	G 1.1/2" x	27	92	86	55	DKR 1.1/2 DN 32 90°	208193
	40	1.1/2"	G 1.1/2" x	33,5	106	93	55	DKR 1.1/2 DN 40 90°	202289
	50	2"	G 2" x	40	129	112	70	DKR 2 DN 50 90°	202290

* Werte können abweichend sein / Values may differ

DKRF (BSPP Female Flat Seal)

- Gerader Nippel
- Flachdichtend
- Gewinde: BSPP

- BSPP Female Flat Face Hose Tail
- Flat Seal
- Thread: BSPP

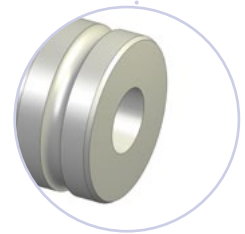
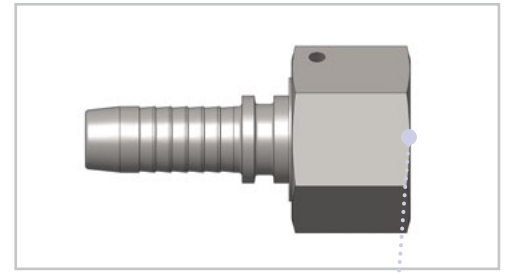
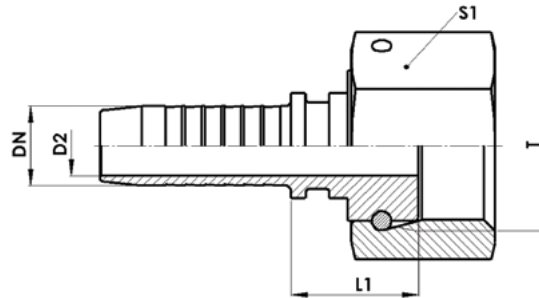

DKRF (BSPP Female Flat Seal)

Schlauch Hose		T	D2	L1	S1	Bezeichnung Description	Artikel-Nr. Article No.
DN	Ø inch		mm	mm	mm		
6	1/4"	G 1/8"	4,5	15	14	DKRF 1/8 DN 06	208180
6	1/4"	G 1/4"	4,5	17	17	DKRF 1/4 DN 06	208194
6	1/4"	G 3/8"	4,5	17	22	DKRF 3/8 DN 06	208195
8	1/4"	G 1/4"	5,5	17	17	DKRF 1/4 DN 08	208196
8	5/16"	G 3/8"	5,5	17	22	DKRF 3/8 DN 08	208197
10	5/16"	G 1/4"	7	17	17	DKRF 1/4 DN 10	208198
10	3/8"	G 3/8"	7	17	22	DKRF 3/8 DN 10	201497
10	3/8"	G 1/2"	7	19	27	DKRF 1/2 DN 10	208199
12	3/8"	G 3/8"	10	18	22	DKRF 3/8 DN 12	208200
12	1/2"	G 1/2"	10	20	27	DKRF 1/2 DN 12	200682
12	5/8"	G 3/4"	10	20	32	DKRF 3/4 DN 12	208201
16	3/4"	G 1/2"	13	19	27	DKRF 1/2 DN 16	208202
16	1"	G 3/4"	13	19	32	DKRF 3/4 DN 16	201343
20	1.1/4"	G 1/2"	15,5	20	27	DKRF 1/2 DN 20	208203
20	1.1/2"	G 3/4"	15,5	20	32	DKRF 3/4 DN 20	208204
20	1/4"	G 1"	15,5	20	41	DKRF 1 DN 20	201344
25	5/16"	G 1"	21,5	21	41	DKRF 1 DN 25	208205
25	3/8"	G 1.1/4"	21,5	22	50	DKRF 1.1/4 DN 25	208206
32	1.1/4"	G 1.1/4"	27	23	50	DKRF 1.1/4 DN 32	116755
32	3/8"	G 1.1/2"	27	24	55	DKRF 1.1/2 DN 32	208207
40	1/2"	G 1.1/2"	33,5	24	55	DKRF 1.1/2 DN 40	208208
50	5/8"	G 2"	40	31	70	DKRF 2 DN 50	208209

DKRF 90° (BSPP Female Flat Seal 90°)

- Nippel 90°-Bogen
- Flachdichtend
- Gewinde: BSPP

- BSPP Female Flat Face 90° Swept Bend Hose Tail
- Flat Seal
- Thread: BSPP

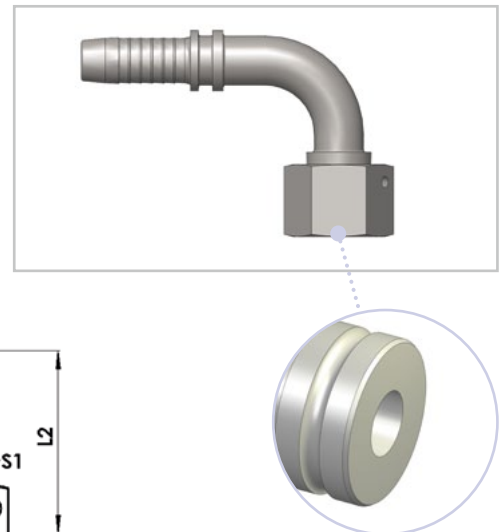
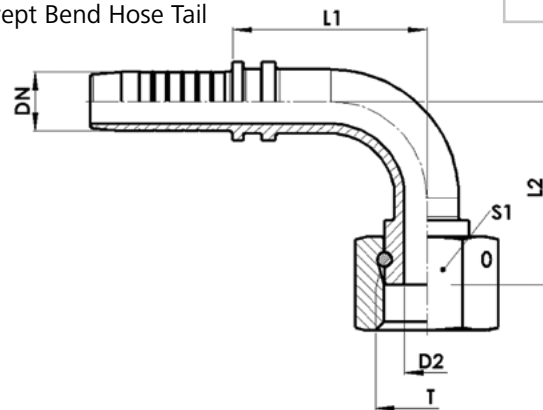

DKRF 90° (BSPP Female Flat Seal 90°)

Schlauch Hose		T	D2	L1*	L2*	S1	Bezeichnung Description	Artikel-Nr. Article No.
DN	Ø inch		mm	mm	mm	mm		
6	1/4"	G 1/8"	4,5	32	24	14	DKRF 1/8 DN 06 90°	208186
6	1/4"	G 1/4"	4,5	32	28	17	DKRF 1/4 DN 06 90°	208210
6	1/4"	G 3/8"	4,5	32	30	22	DKRF 3/8 DN 06 90°	208211
8	5/16"	G 1/4"	5,5	35	30	17	DKRF 1/4 DN 08 90°	208212
8	5/16"	G 3/8"	5,5	35	32	22	DKRF 3/8 DN 08 90°	208213
10	3/8"	G 1/4"	7	39	32	17	DKRF 1/4 DN 10 90°	208214
10	3/8"	G 3/8"	7	39	33	22	DKRF 3/8 DN 10 90°	208215
10	3/8"	G 1/2"	7	39	36	27	DKRF 1/2 DN 10 90°	208216
12	1/2"	G 3/8"	10	43	39	22	DKRF 3/8 DN 12 90°	208217
12	1/2"	G 1/2"	10	43	39	27	DKRF 1/2 DN 12 90°	208218
12	1/2"	G 3/4"	10	43	42	32	DKRF 3/4 DN 12 90°	208219
16	5/8"	G 1/2"	13	50	45	27	DKRF 1/2 DN 16 90°	208220
16	5/8"	G 3/4"	13	50	49	32	DKRF 3/4 DN 16 90°	208221
16	5/8"	G 5/8"	13	50	45	30	DKRF 5/8 DN 16 90°	222428
20	3/4"	G 1/2"	15,5	62	50	27	DKRF 1/2 DN 20 90°	208222
20	3/4"	G 3/4"	15,5	62	49	32	DKRF 3/4 DN 20 90°	208223
20	3/4"	G 1"	15,5	62	52	41	DKRF 1 DN 20 90°	208224
25	1"	G 1"	21,5	83	63	41	DKRF 1 DN 25 90°	208225
25	1"	G 1.1/4"	21,5	83	69	50	DKRF 1.1/4 DN 25 90°	208226
32	1.1/4"	G 1.1/4"	27	91	79	50	DKRF 1.1/4 DN 32 90°	222430
32	1.1/4"	G 1.1/2"	27	91	81	55	DKRF 1 1/2 DN 32 90°	208227
40	1.1/2"	G 1.1/2"	33,5	106	88	55	DKRF 1 1/2 DN 40 90°	208228
50	2"	G 2"	40	129	107	70	DKRF 2 DN 50 90°	208229

* Werte können abweichend sein / Values may differ

AGJ (JIC)

- Gerader Nippel
- mit 37° JIC-Dichtkegel
- Gewinde: UNF

- JIC Male Hose Tail
- with 37° JIC Swivel
- Thread: UNF

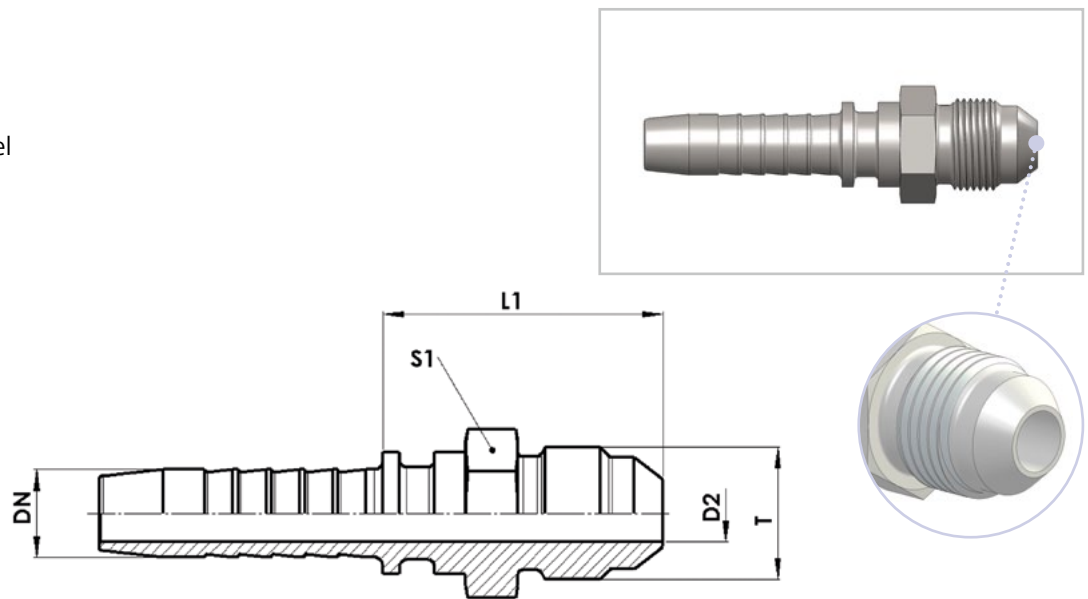

AGJ (JIC)

Schlauch Hose		T	D2	L1	S1	Bezeichnung Description	Artikel-Nr. Article No.
DN	Ø inch		mm	mm	mm		
5	3/16"	7/16"-20 UNF	2,7	26	14	AGJ 7/16 DN 05	222310
5	3/16"	1/2"-20 UNF	2,7	26	14	AGJ 1/2 DN 05	222312
5	3/16"	9/16"-18 UNF	2,7	26	17	AGJ 9/16 DN 05	222311
6	1/4"	7/16"-20 UNF	4,5	27	14	AGJ 7/16 DN 06	201883
6	1/4"	1/2"-20 UNF	4,5	27	14	AGJ 1/2 DN 06	201884
6	1/4"	9/16"-18 UNF	4,5	27	17	AGJ 9/16 DN 06	201885
8	5/16"	1/2"-20 UNF	5,5	27	14	AGJ 1/2 DN 08	201886
8	5/16"	9/16"-18 UNF	5,5	27	17	AGJ 9/16 DN 08	201887
10	3/8"	9/16"-18 UNF	7,1	28	17	AGJ 9/16 DN 10	201888
10	3/8"	3/4"-16 UNF	7,1	31	19	AGJ 3/4 DN 10	201889
12	1/2"	3/4"-16 UNF	9,7	32	19	AGJ 3/4 DN 12	201890
12	1/2"	7/8"-14 UNF	9,7	35	24	AGJ 7/8 DN 12	201891
16	5/8"	7/8"-14 UNF	13	34	24	AGJ 7/8 DN 16	201892
16	5/8"	1.1/16"-12 UNF	13	38	30	AGJ 1 1/16 DN 16	201893
20	3/4"	1.1/16"-12 UNF	15,4	39	30	AGJ 1 1/16 DN 20	200621
20	3/4"	1.5/16"-12 UNF	15,4	41	36	AGJ 1.5/16 DN 20	201894
25	1"	1.5/16"-12 UNF	21,4	42	36	AGJ 1 5/16 DN 25	201895
25	1"	1.5/8"-12 UNF	21,4	43	46	AGJ 1 5/8 DN 25	201896
32	1.1/4"	1.5/8"-12 UNF	27	45	46	AGJ 1 5/8 DN 32	201897
40	1.1/2"	1.7/8"-12 UNF	33,3	51	50	AGJ 1 7/8 DN 40	201898
50	2"	2.1/2"-12 UNF	40	61	65	AGJ 2 1/2 DN 50	201899

DKJ (JIC Female)

- Gerader Nippel
- mit 37° JIC-Dichtkegel
- Gewinde: UNF

- JIC Female Hose Tail
- with 37° JIC Swivel
- Thread: UNF

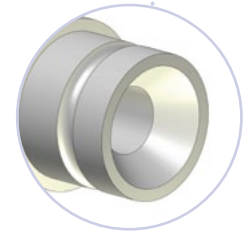
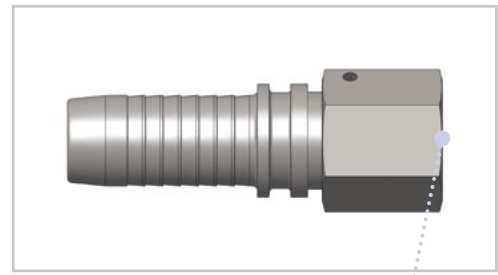
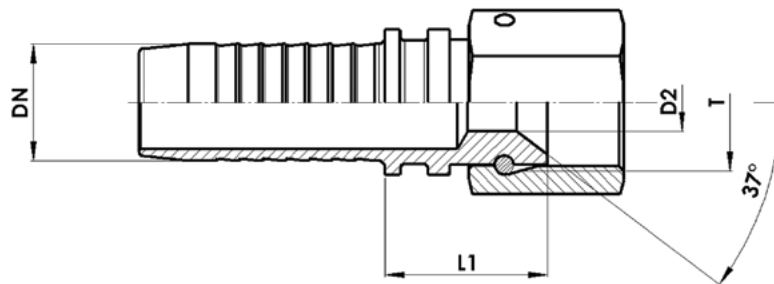

DKJ (JIC Female)

Schlauch Hose		T	D2	L1	S1	Bezeichnung Description	Artikel-Nr. Article No.
DN	Ø inch		mm	mm	mm		
5	3/16"	7/16"-20 UNF	2,7	15	14	DKJ 7/16 DN 05	222383
5	3/16"	1/2"-20 UNF	2,7	16	17	DKJ 1/2 DN 05	222384
5	3/16"	9/16"-18 UNF	2,7	16	19	DKJ 9/16 DN 05	222385
6	1/4"	7/16"-20 UNF	4,5	16	14	DKJ 7/16 DN 06	201733
6	1/4"	1/2"-20 UNF	4,5	17	17	DKJ 1/2 DN 06	201735
6	1/4"	9/16"-18 UNF	4,5	17	19	DKJ 9/16 DN 06	201737
8	5/16"	1/2"-20 UNF	5,5	17	17	DKJ 1/2 DN 08	201739
8	5/16"	9/16"-18 UNF	5,5	17	19	DKJ 9/16 DN 08	201568
10	3/8"	9/16"-18 UNF	7,1	18	19	DKJ 9/16 DN 10	201741
10	3/8"	3/4"-16 UNF	7,1	22	22	DKJ 3/4 DN 10	201743
10	3/8"	7/8"-14 UNF	7,1	19	27	DKJ 7/8 DN 10	206962
12	1/2"	9/16"-18 UNF	9,7	18	19	DKJ 9/16 DN 12	206963
12	1/2"	3/4"-16 UNF	9,7	23	22	DKJ 3/4 DN 12	200998
12	1/2"	7/8"-14 UNF	9,7	20	27	DKJ 7/8 DN 12	201745
12	1/2"	1.1/16"-12 UNF	9,7	22	32	DKJ 1 1/16 DN 12	206964
16	5/8"	3/4"-16 UNF	13	23	22	DKJ 3/4 DN 16	201747
16	5/8"	7/8"-14 UNF	13	20	27	DKJ 7/8 DN 16	201720
16	5/8"	1.1/16"-12 UNF	13	22	32	DKJ 1 1/16 DN 16	201749
20	3/4"	1.1/16"-12 UNF	15,4	22	32	DKJ 1 1/16 DN 20	201003
20	3/4"	1.5/16"-12 UNF	15,4	23	41	DKJ 1 5/16 DN 20	201569
25	1"	1.1/16"-12 UNF	21,4	24	32	DKJ 1 1/16 DN 25	206965
25	1"	1.5/16"-12 UNF	21,4	25	41	DKJ 1 5/16 DN 25	201719
32	1.1/4"	1.5/8"-12 UNF	27	27	50	DKJ 1 5/8 DN 32	201751
40	1.1/2"	1.7/8"-12 UNF	33,3	30	60	DKJ 1 7/8 DN 40	201753
50	2"	2.1/2"-12 UNF	40	34	75	DKJ 2 1/2 DN 50	201755

DKJ 45° (JIC Female 45°)

- Nippel 45°-Bogen
- mit 37° JIC-Dichtkegel
- Gewinde: UNF

- JIC Female 45° Swept Bend Hose Tail
- with 37° JIC Swivel
- Thread: UNF

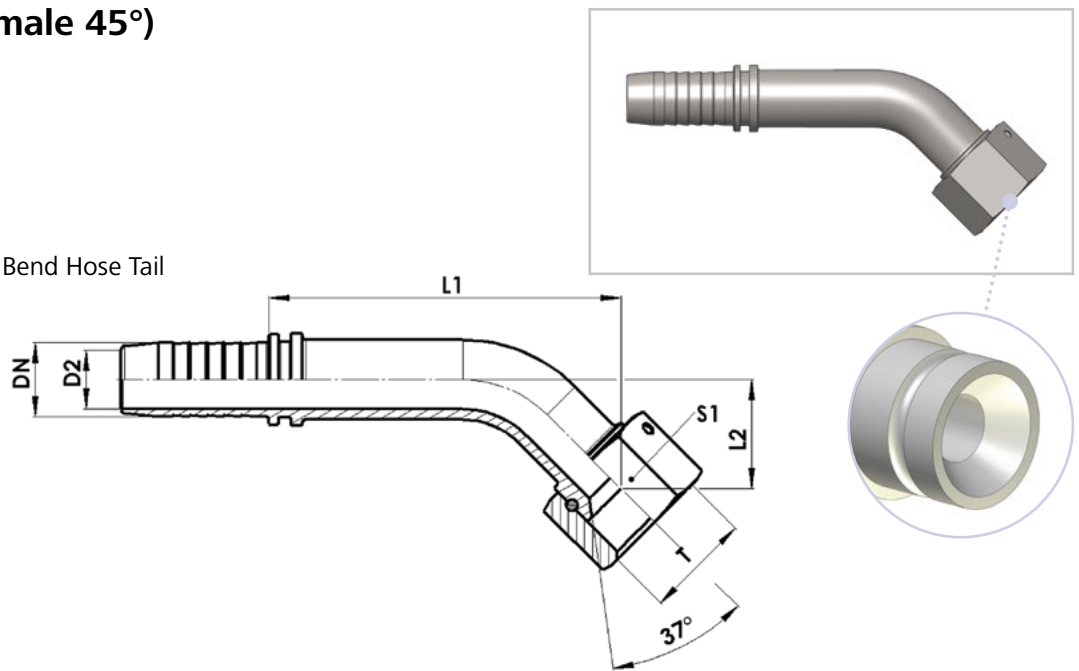

DKJ 45° (JIC Female 45°)

Schlauch Hose		T	D2	L1*	L2*	S1	Bezeichnung Description	Artikel-Nr. Article No.
DN	Ø inch		mm	mm	mm	mm		
6	1/4"	7/16"-20 UNF	4,5	33	13	14	DKJ 7/16 DN 06 45°	208234
6	1/4"	1/2"-20 UNF	4,5	34	14	17	DKJ 1/2 DN 06 45°	208259
6	1/4"	9/16"-18 UNF	4,5	34	14	17	DKJ 9/16 DN 06 45°	208260
8	5/16"	1/2"-20 UNF	5,5	38	14	17	DKJ 1/2 DN 08 45°	208261
8	5/16"	9/16"-18 UNF	5,5	38	14	17	DKJ 9/16 DN 08 45°	208262
10	3/8"	9/16"-18 UNF	7,1	41	15	17	DKJ 9/16 DN 10 45°	208263
10	3/8"	3/4"-16 UNF	7,1	44	18	22	DKJ 3/4 DN 10 45°	208264
10	3/8"	7/8"-14 UNF	7,1	43	16	27	DKJ 7/8 DN 10 45°	208265
12	1/2"	3/4"-16 UNF	9,7	51	19	22	DKJ 3/4 DN 12 45°	208266
12	1/2"	7/8"-14 UNF	9,7	49	17	27	DKJ 7/8 DN 12 45°	208267
12	1/2"	1.1/16"-12 UNF	9,7	50	19	32	DKJ 1.1/16 DN 12 45°	208268
16	5/8"	7/8"-14 UNF	13	59	20	27	DKJ 7/8 DN 16 45°	201722
16	5/8"	1.1/16"-12 UNF	13	60	22	32	DKJ 1.1/16 DN 16 45°	208269
20	3/4"	1.1/16"-12 UNF	15,4	63	23	32	DKJ 1.1/16 DN 20 45°	208270
20	3/4"	1.5/16"-12 UNF	15,4	64	23	41	DKJ 1.5/16 DN 20 45°	208271
25	1"	1.5/16"-12 UNF	21,4	80	28	41	DKJ 1.5/16 DN 25 45°	201721
25	1"	1.5/8"-12 UNF	21,4	81	30	50	DKJ 1.5/8 DN 25 45°	208272
32	1.1/4"	1.5/8"-12 UNF	27	95	33	50	DKJ 1.5/8 DN 32 45°	208273
32	1.1/4"	1.7/8"-12 UNF	27	97	35	60	DKJ 1.7/8 DN 32 45°	208274
40	1.1/2"	1.7/8"-12 UNF	33,3	111	38	60	DKJ 1.7/8 DN 40 45°	208275
40	1.1/2"	2.1/2"-12 UNF	33,3	114	41	75	DKJ 2.1/2 DN 40 45°	208276
50	2"	2.1/2"-12 UNF	40	132	46	75	DKJ 2.1/2 DN 50 45°	208277

* Werte können abweichend sein / Values may differ

DKJ 90° (JIC Female 90°)

- Nippel 90°-Bogen
- mit 37° JIC-Dichtkegel
- Gewinde: UNF

- JIC Female 90° Swept Bend Hose Tail
- with 37° JIC Swivel
- Thread: UNF

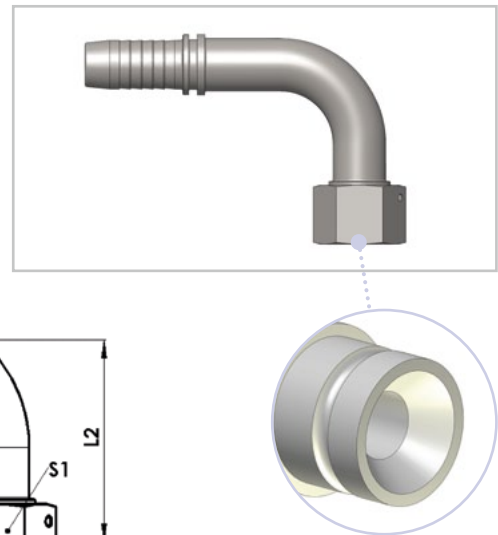
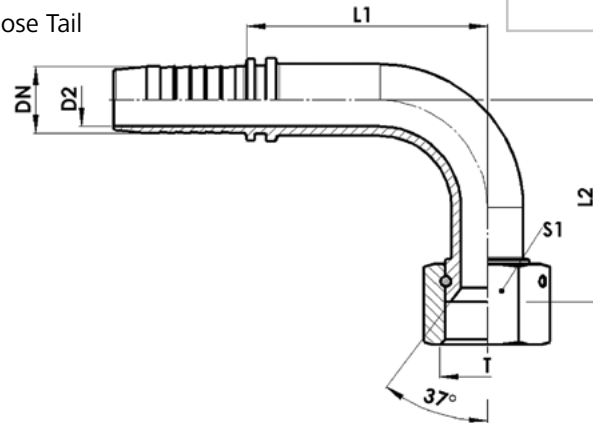

DKJ 90° (JIC Female 90°)

Schlauch Hose		T	D2	L1*	L2*	S1	Bezeichnung Description	Artikel-Nr. Article No.
DN	Ø inch		mm	mm	mm	mm		
6	1/4"	7/16"-20 UNF	4,5	31	25,8	14	DKJ 7/16 DN 06 90°	202303
6	1/4"	1/2"-20 UNF	4,5	31	27	17	DKJ 1/2 DN 06 90°	202306
6	1/4"	9/16"-18 UNF	4,5	31	27	17	DKJ 9/16 DN 06 90°	202300
8	5/16"	1/2"-20 UNF	5,5	35	30,5	17	DKJ 1/2 DN 08 90°	202305
8	5/16"	9/16"-18 UNF	5,5	35	30,5	17	DKJ 9/16 DN 08 90°	206617
10	3/8"	9/16"-18 UNF	7,1	42	29,5	17	DKJ 9/16 DN 10 90°	202293
10	3/8"	3/4"-16 UNF	7,1	42	34	22	DKJ 3/4 DN 10 90°	202304
10	3/8"	7/8"-14 UNF	7,1	42	31	27	DKJ 7/8 DN 10 90°	208235
12	1/2"	3/4"-16 UNF	9,7	45	40	22	DKJ 3/4 DN 12 90°	208278
12	1/2"	7/8"-14 UNF	9,7	45	37	27	DKJ 7/8 DN 12 90°	202302
12	1/2"	1.1/16"-12 UNF	9,7	45	39	32	DKJ 1.1/16 DN 12 90°	206786
16	5/8"	7/8"-14 UNF	13	50	44	27	DKJ 7/8 DN 16 90°	208279
16	5/8"	1.1/16"-12 UNF	13	50	46	32	DKJ 1.1/16 DN 16 90°	202291
20	3/4"	1.1/16"-12 UNF	15,4	64	52	32	DKJ 1.1/16 DN 20 90°	201004
20	3/4"	1.5/16"-12 UNF	15,4	64	53	41	DKJ 1.5/16 DN 20 90°	208280
25	1"	1.5/16"-12 UNF	21,4	82	66	41	DKJ 1.5/16 DN 25 90°	208281
25	1"	1.5/8"-12 UNF	21,4	82	68	50	DKJ 1.5/8 DN 25 90°	208282
32	1.1/4"	1.5/8"-12 UNF	27	92	78	50	DKJ 1.5/8 DN 32 90°	202308
32	1.1/4"	1.7/8"-12 UNF	27	92	80,5	60	DKJ 1.7/8 DN 32 90°	208283
40	1.1/2"	1.7/8"-12 UNF	33,3	103	98	60	DKJ 1.7/8 DN 40 90°	202307
40	1.1/2"	2.1/2"-12 UNF	33,3	103	102	75	DKJ 2.1/2 DN 40 90°	208284
50	2"	2.1/2"-12 UNF	40	122	123	75	DKJ 2.1/2 DN 50 90°	206788

* Werte können abweichend sein / Values may differ

CE (Metric Male)

- Gerader Nippel
 - für 24°-Schneidringverschraubung
 - L- und S-Reihe
-
- Metric Male L/S Hose Tail
 - with 24° Cone Sealing End
 - L and S Series

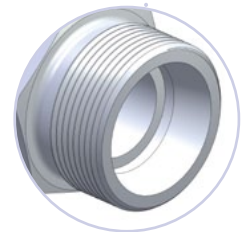
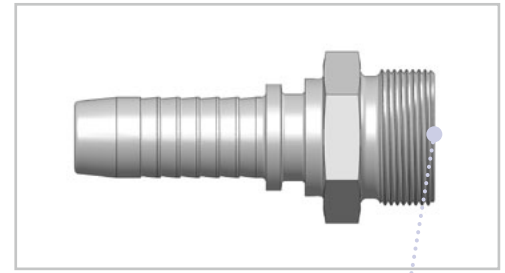
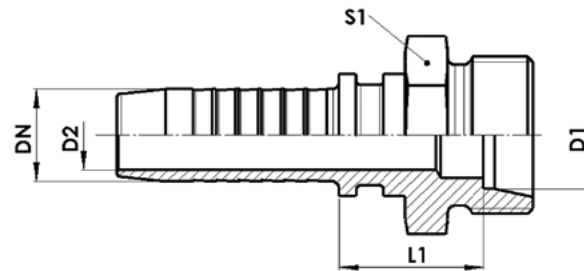

CE (Metric Male)								
Baureihe Series	Schlauch Hose	D1	D2	L1	S1	Bezeichnung Description	Artikel-Nr. Article No.	
	DN Ø inch	mm	mm	mm	mm			
L	5	3/16"	6	2,7	15	12	CE 06L DN05	222291
	5	3/16"	8	2,7	15	14	CE 08L DN05	222292
	6	1/4"	6	4,5	17	12	CE 06L DN06	206967
	6	1/4"	8	4,5	16	14	CE 08L DN06	201455
	6	1/4"	10	4,5	18	17	CE 10L DN06	215454
	8	5/16"	10	5,5	17	17	CE 10L DN08	200660
	8	5/16"	12	5,5	18	19	CE 12L DN08	202136
	10	3/8"	10	7,1	18	17	CE 10L DN10	202134
	10	3/8"	12	7,1	19	19	CE 12L DN10	201053
	10	3/8"	15	7,1	20	24	CE 15L DN10	202139
	12	1/2"	12	9,7	19	19	CE 12L DN12	222293
	12	1/2"	15	9,7	20	24	CE 15L DN12	200979
	12	1/2"	18	9,7	21	27	CE 18L DN12	202141
	16	5/8"	18	13	21	27	CE 18L DN16	200989
	16	5/8"	22	13	23	32	CE 22L DN16	222294
	20	3/4"	18	15,4	22	27	CE 18L DN20	222295
	20	3/4"	22	15,4	23	32	CE 22L DN20	202144
	20	3/4"	28	15,4	25	41	CE 28L DN20	222296
	25	1"	28	21,4	26	41	CE 28L DN25	202147
	32	1.1/4"	35	27	27	46	CE 35L DN32	202149
40	1.1/2"	42	33,3	28	55	CE 42L DN40	202151	
S	5	3/16"	6	2,7	10	14	CE 06S DN05	222297
	5	3/16"	8	2,7	11	19	CE 08S DN05	222298
	6	1/4"	6	4,5	19	14	CE 06S DN06	202133
	6	1/4"	8	4,5	21	17	CE 08S DN06	206969
	6	1/4"	10	4,5	21	19	CE 10S DN06	202135
	8	5/16"	12	5,5	23	22	CE 12S DN08	202137
	10	3/8"	10	7,1	20	19	CE 10S DN10	215453
	10	3/8"	12	7,1	24	22	CE 12S DN10	201456
	10	3/8"	14	7,1	23	24	CE 14S DN10	202138
	10	3/8"	16	7,1	24	27	CE 16S DN10	222299
	12	1/2"	16	9,7	25	27	CE 16S DN12	202140
	12	1/2"	20	9,7	21	27	CE 20S DN12	222300
	16	5/8"	20	13	27	32	CE 20S DN16	202142
	20	3/4"	20	15,4	27	32	CE 20S DN20	202143
	20	3/4"	25	15,4	29	41	CE 25S DN20	202145
	25	1"	25	21,4	31	41	CE 25S DN25	202146
	25	1"	30	21,4	32	46	CE 30S DN25	202148
	32	1.1/4"	38	27	35	55	CE 38S DN32	202150

AGR (BSPP)

- Gerader Nippel
- mit 60°-Dichtkegel
- Gewinde: BSPP
- Abdichtung durch met. Dichtkante Form B

- BSPP Male Hose Tail
- with 60° Cone End
- Thread: BSPP
- Metal Sealing Edge Form B

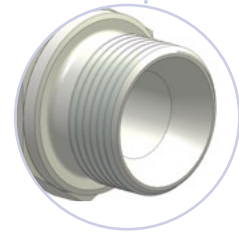
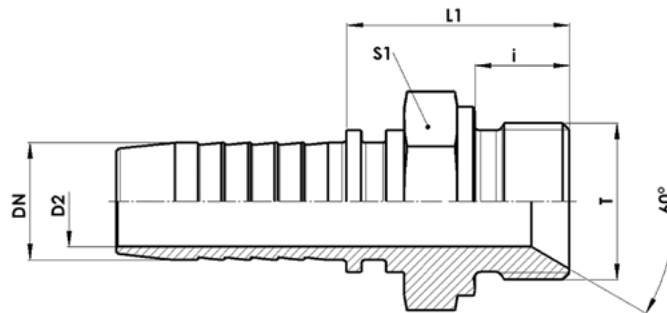
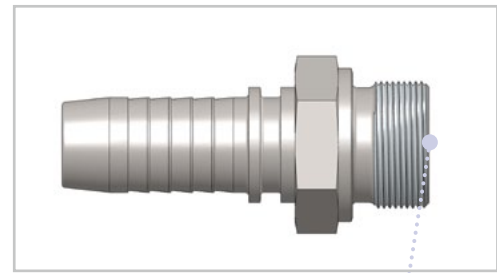

AGR (BSPP)

Schlauch Hose		T	D2	L1	S1	i	Bezeichnung Description	Artikel-Nr. Article No.
DN	Ø inch		mm	mm	mm	mm		
5	3/16"	G 1/8"	2,7	22	14	8	AGR 1/8 DN 05	222381
5	3/16"	G 1/4"	2,7	28	19	12	AGR 1/4 DN 05	222382
6	1/4"	G 1/8"	4,5	23	14	8	AGR 1/8 DN 06	202080
6	1/4"	G 1/4"	4,5	30	19	12	AGR 1/4 DN 06	200672
8	5/16"	G 1/4"	5,5	30	19	12	AGR 1/4 DN 08	202081
8	5/16"	G 3/8"	5,5	31	22	12	AGR 3/8 DN 08	201083
10	3/8"	G 1/4"	7,1	31	19	12	AGR 1/4 DN 10	202082
10	3/8"	G 3/8"	7,1	31	22	12	AGR 3/8 DN 10	200841
10	3/8"	G 1/2"	7,1	35	27	14	AGR 1/2 DN 10	202084
12	1/2"	G 3/8"	9,7	32	22	12	AGR 3/8 DN 12	202083
12	1/2"	G 1/2"	9,7	35	27	14	AGR 1/2 DN 12	200673
16	5/8"	G 1/2"	13	35	27	14	AGR 1/2 DN 16	201796
16	5/8"	G 3/4"	13	37	32	16	AGR 3/4 DN 16	202085
20	3/4"	G 3/4"	15,4	38	32	16	AGR 3/4 DN 20	200674
20	3/4"	G 1"	15,4	41	41	18	AGR 1 DN 20	202086
25	1"	G 1"	21,4	42	41	18	AGR 1 DN 25	219455
25	1"	G 1.1/4"	21,4	47	50	20	AGR 1.1/4 DN 25	202087
32	1.1/4"	G 1.1/4"	27	48	50	20	AGR 1.1/4 DN 32	202088
32	1.1/4"	G 1.1/2"	27	40	55	22	AGR 1.1/2 DN 32	202089
40	1.1/2"	G 1.1/2"	33,3	50	55	22	AGR 1.1/2 DN 40	201111
50	2"	G 2"	40	56	70	24	AGR 2 DN 50	202090

AGR WD (BSPP WD)

- Gerader Nippel
- mit 60°-Dichtkegel
- Gewinde: BSPP
- Abdichtung durch Viton Profidichtung DIN 3869

- BSPP Male WD Hose Tail
- with 60° Cone End
- Thread: BSPP
- Sealing by Viton Profiled Ring DIN 3869

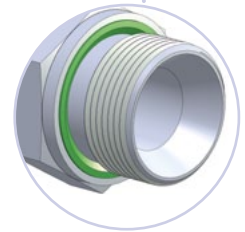
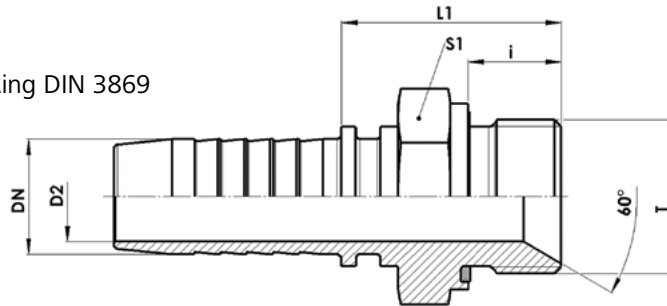
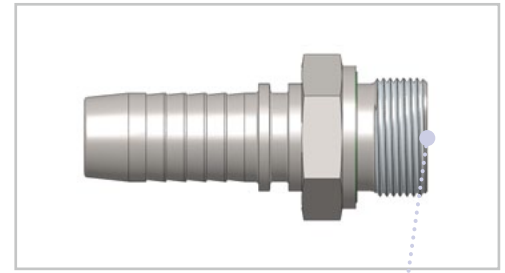

AGR WD (BSPP WD)

Schlauch Hose		T	D2	L1	S1	i	Bezeichnung Description	Artikel-Nr. Article No.
DN	Ø inch		mm	mm	mm	mm		
6	1/4"	G 1/8"	4,5	33		8	AGR 1/8 DN 06 WD	208232
6	1/4"	G 1/4"	4,5	30	19	12	AGR 1/4 DN 06 WD	208306
8	5/16"	G 1/4"	5,5	30	19	12	AGR 1/4 DN 08 WD	208307
8	5/16"	G 3/8"	5,5	31	22	12	AGR 3/8 DN 08 WD	208308
10	3/8"	G 1/4"	7,1	31	19	12	AGR 1/4 DN 10 WD	208309
10	3/8"	G 3/8"	7,1	31	22	12	AGR 3/8 DN 10 WD	208310
10	3/8"	G 1/2"	7,1	35	27	14	AGR 1/2 DN 10 WD	208311
12	1/2"	G 3/8"	9,7	32	22	12	AGR 3/8 DN 12 WD	208312
12	1/2"	G 1/2"	9,7	36	27	14	AGR 1/2 DN 12 WD	208313
16	5/8"	G 1/2"	13	35	27	14	AGR 1/2 DN 16 WD	208314
16	5/8"	G 3/4"	13	37	32	16	AGR 3/4 DN 16 WD	208315
20	3/4"	G 3/4"	15,4	38	32	16	AGR 3/4 DN 20 WD	208316
20	3/4"	G 1"	15,4	41	41	18	AGR 1 DN 20 WD	208317
25	1"	G 1"	21,4	42	41	18	AGR 1 DN 25 WD	208318
25	1"	G 1.1/4"	21,4	47	50	20	AGR 1.1/4 DN 25 WD	208319
32	1.1/4"	G 1.1/4"	27	48	50	20	AGR 1.1/4" DN 32 WD	208320
32	1.1/4"	G 1.1/2"	27	50	55	22	AGR 1.1/2 DN 32 WD	208321
40	1.1/2"	G 1.1/2"	33,3	50	55	22	AGR 1.1/2 DN 40 WD	208322
50	2"	G 2"	40	56	70	24	AGR 2 DN 50 WD	208323

AGR BSPT-m (BSPT Male)

- Gerader Nippel
- mit 60°-Dichtkegel
- Gewinde: BSPT

- BSPT Male Hose Tail
- with 60° Cone End
- Thread: BSPT

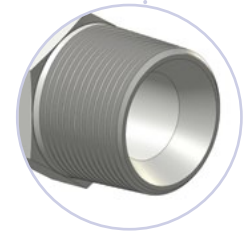
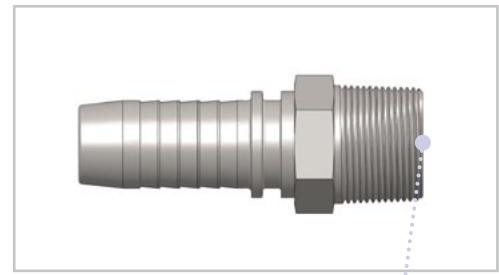
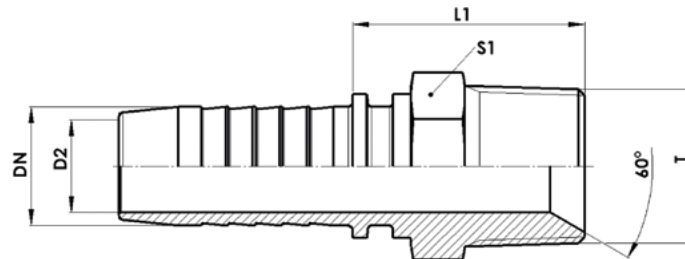

AGR BSPT-m (BSPT Male)

Schlauch Hose		T	D2	L1	S1	Bezeichnung Description	Artikel-Nr. Article No.
DN	Ø inch		mm	mm	mm		
6	1/4"	G 1/8"	4,5	22	12	AGR 1/8 BSPT-m DN 06	202107
6	1/4"	G 1/4"	4,5	30	14	AGR 1/4 BSPT-m DN 06	200676
6	1/4"	G 3/8"	4,5	31	17	AGR 3/8 BSPT-m DN 06	206954
8	5/16"	G 3/8"	5,5	30	19	AGR 3/8 BSPT-m DN 08	202108
10	3/8"	G 1/4"	7,1	32	17	AGR 1/4 BSPT-m DN 10	206955
10	3/8"	G 3/8"	7,1	31	19	AGR 3/8 BSPT-m DN 10	200982
10	3/8"	G 1/2"	7,1	36	22	AGR 1/2 BSPT-m DN 10	202109
12	1/2"	G 3/8"	9,7	32	19	AGR 3/8 BSPT-m DN 12	206956
12	1/2"	G 1/2"	9,7	37	22	AGR 1/2 BSPT-m DN 12	200677
12	1/2"	G 3/4"	9,7	38	27	AGR 3/4 BSPT-m DN 12	202112
16	5/8"	G 1/2"	13	37	22	AGR 1/2 BSPT-m DN 16	202110
16	5/8"	G 3/4"	13	38	27	AGR 3/4 BSPT-m DN 16	202113
16	5/8"	G 5/8"	13	36	24	AGR 5/8 BSPT-m DN 16	202111
20	3/4"	G 3/4"	15,4	39	27	AGR 3/4 BSPT-m DN 20	200678
20	3/4"	G 1"	15,4	43	36	AGR 1 BSPT-m DN 20	202114
25	1"	G 1"	21,4	45	41	AGR 1 BSPT-m DN 25	200679
32	1.1/4"	G 1.1/4"	27	51	46	AGR 1 1/4 BSPT-m DN 32	200680
40	1.1/2"	G 1.1/2"	33,3	51	50	AGR 1 1/2 BSPT-m DN 40	202510
50	2"	G 2"	40	59	65	AGR 2 BSPT-m DN 50	202115

AGN (NPT)

- Gerader Nippel
 - mit 60°-Dichtkegel
 - Gewinde: NPT
-
- NPT Male Hose Tail
 - with 60° Cone End
 - Thread: NPT

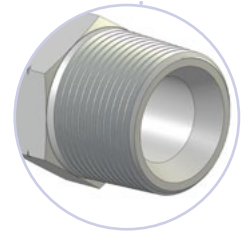
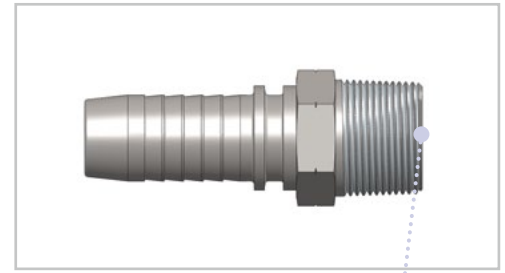
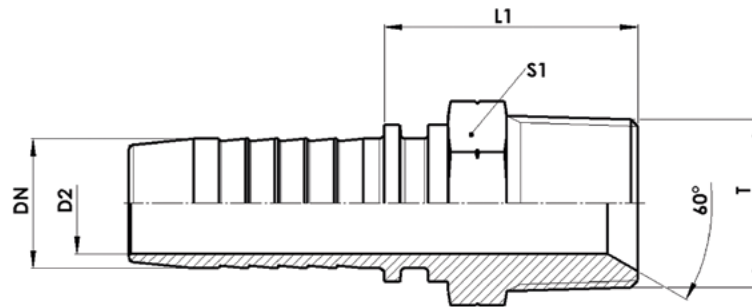

AGN (NPT)

Schlauch Hose		T	D2	L1	S1	Bezeichnung Description	Artikel-Nr. Article No.
DN	Ø inch		mm	mm	mm		
6	1/4"	1/8" NPT	4,5	23	12	AGN 1/8 DN 06	202030
6	1/4"	1/4" NPT	4,5	31	14	AGN 1/4 DN 06	202031
6	1/4"	3/8" NPT	4,5	31	19	AGN 3/8 DN 06	202034
8	5/16"	1/4" NPT	5,5	31	14	AGN 1/4 DN 08	202032
8	5/16"	3/8" NPT	5,5	31	19	AGN 3/8 DN 08	202035
10	3/8"	1/4" NPT	7,1	32	17	AGN 1/4 DN 10	206957
10	3/8"	3/8" NPT	7,1	32	19	AGN 3/8 DN 10	202036
10	3/8"	1/2" NPT	7,1	38	22	AGN 1/2 DN 10	202037
12	1/2"	1/4" NPT	9,7	33	19	AGN 1/4 DN 12	202033
12	1/2"	1/2" NPT	9,7	38	22	AGN 1/2 DN 12	202038
16	5/8"	3/4" NPT	13	38	27	AGN 3/4 DN 16	202039
20	3/4"	3/4" NPT	15,4	39	27	AGN 3/4 DN 20	200620
20	3/4"	1" NPT	15,4	45	36	AGN 1 DN 20	202040
25	1"	1" NPT	21,4	46	36	AGN 1 DN 25	202041
32	1.1/4"	1.1/4" NPT	27	51	46	AGN 1.1/4 DN 32	202042
40	1.1/2"	1.1/2" NPT	33,3	51	50	AGN 1.1/2 DN 40	202043
50	1.1/4"	2" NPT	40	59	65	AGN 2 DN 50	202044

DSN (Hose Connector)

- Gerader Doppelnippel
- Hose Tail Joiner

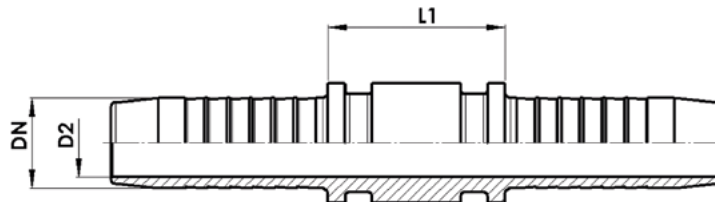
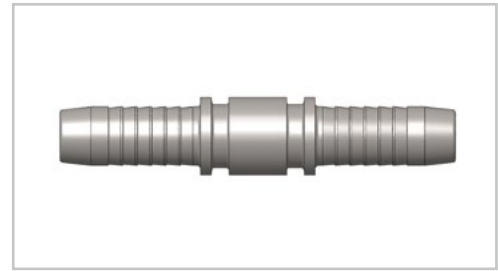

DSN (Hose Connector)

Schlauch Hose		D2	L1	Bezeichnung Description	Artikel-Nr. Article No.
DN	Ø inch	mm	mm		
6	1/4"	4,5	25	DSN DN 06	208156
8	5/16"	5,5	25	DSN DN 08	126802
10	3/8"	7,1	25	DSN DN 10	208157
12	1/2"	9,7	25	DSN DN 12	208159
16	5/8"	13	28	DSN DN 16	208160
20	3/4"	15,4	32	DSN DN 20	208161
25	1"	21,4	34	DSN DN 25	101150
32	1.1/4"	27	41	DSN DN 32	208162
40	1.1/2"	33,3	42	DSN DN 40	201405
50	2"	40	41	DSN DN 50	208163

SFL3 / SFS6 (Code 61 / 62)

- Gerader Nippel
- mit SAE-Flansch und O-Ring Viton
- SFL3 = 3000 psi
- SFS6 = 6000 psi

- Code 61/62 Flange Hose Tail
- with SAE Flange and Viton O-Ring
- SFL3 = 3000 psi
- SFS6 = 6000 psi

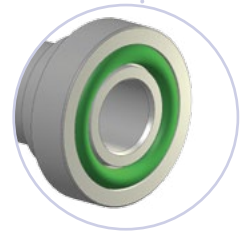
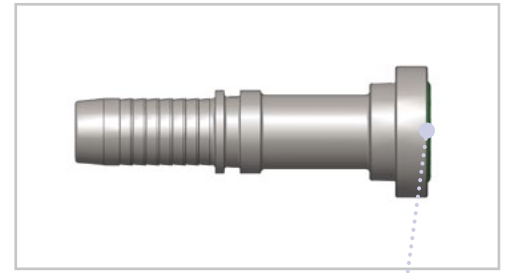
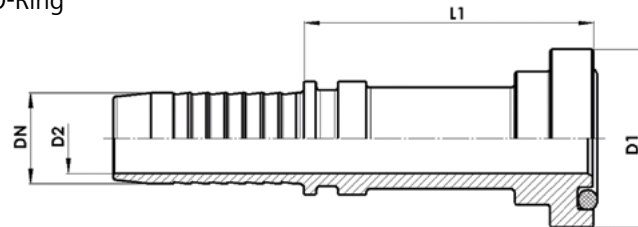

SFL3 / SFS6 (Code 61 / 62)

Baureihe Series	Schlauch Hose		Flanschgröße Flange size		D2 mm	L1 mm	Bezeichnung Description	Artikel-Nr. Article No.
	DN	Ø inch	D1	inch				
SFL3	12	1/2"	30	1/2"	9,7	38	SFL3 1/2" DN 12	208233
	12	1/2"	38	3/4"	9,7	43	SFL3 3/4" DN 12	208373
	16	5/8"	30	1/2"	13	40	SFL3 1/2" DN 16	208374
	16	5/8"	38	3/4"	13	46	SFL3 3/4" DN 16	208375
	20	3/4"	38	3/4"	15,4	47	SFL3 3/4" DN 20	208376
	20	3/4"	44	1"	15,4	49	SFL3 1" DN 20	208377
	25	1"	44	1"	21,4	48	SFL3 1" DN 25	208378
	25	1"	51	1.1/4"	21,4	50	SFL3 1 1/4" DN 25	208379
	32	1.1/4"	51	1.1/4"	27	55	SFL3 1 1/4" DN 32	208380
	32	1.1/4"	60	1.1/2"	27	52	SFL3 1 1/2" DN 32	208381
SFS6	40	1.1/2"	60	1.1/2"	33,3	59	SFL3 1 1/2" DN 40	208382
	40	1.1/2"	71	2"	33,3	53	SFL3 2" DN 40	208383
	50	2"	71	2"	40	60	SFL3 2" DN 50	208384
	12	1/2"	32	1/2"	9,7	39	SFS6 1/2" DN 12	208385
	12	1/2"	41	3/4"	9,7	40	SFS6 3/4" DN 12	208386
	16	5/8"	32	1/2"	13	40	SFS6 1/2" DN 16	208387
	16	5/8"	41	3/4"	13	41	SFS6 3/4" DN 16	208388
	20	3/4"	41	3/4"	15,4	48	SFS6 3/4" DN 20	208389
	20	3/4"	48	1"	15,4	48	SFS6 1" DN 20	208390
	25	1"	48	1"	21,4	48	SFS6 1" DN 25	208391
25	1"	54	1.1/4"	21,4	53	SFS6 1 1/4" DN 25	208392	
32	1.1/4"	54	1.1/4"	27	65	SFS6 1 1/4" DN 32	208393	
32	1.1/4"	64	1.1/2"	27	66	SFS6 1 1/2" DN 32	208394	
40	1.1/2"	64	1.1/2"	33,3	72	SFS6 1 1/2" DN 40	208395	
40	1.1/2"	79	2"	33,3	74	SFS6 2" DN 40	208396	
50	2"	79	2"	40	75	SFS6 2" DN 50	208397	

SFL3 / SFS6 45° (Code 61 / 62 45°)

- Nippel 45°-Bogen
- mit SAE-Flansch und O-Ring Viton
- SFL3 = 3000 psi
- SFS6 = 6000 psi

- Code 61/62 Flange 45° Swept Bend Hose Tail
- with SAE Flange and Viton O-Ring
- SFL3 = 3000 psi
- SFS6 = 6000 psi

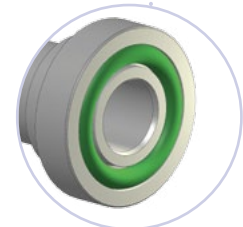
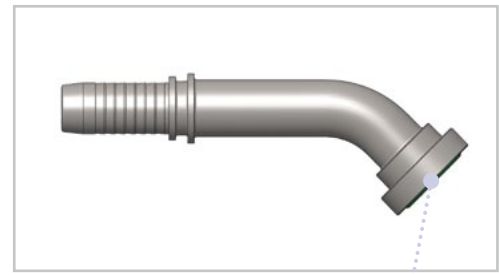
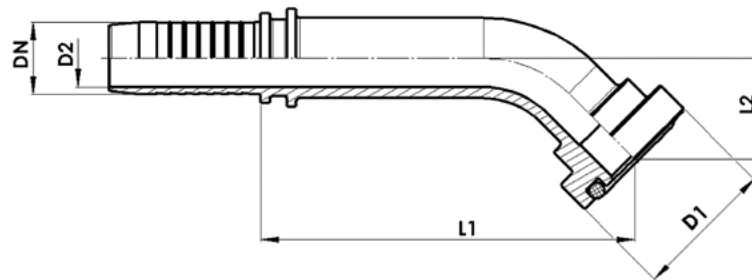

SFL3 / SFS6 45° (Code 61 / 62 45°)

Baureihe Series	Schlauch Hose		Flanschgröße Flange size		D2 mm	L1* mm	L2* mm	Bezeichnung Description	Artikel-Nr. Article No.
	DN	Ø inch	D1	inch					
SFL3	12	1/2"	30	1/2"	9,7	51	19	SFL3 1/2 DN 12 45°	208347
	12	1/2"	38	3/4"	9,7	51	20	SFL3 3/4 DN 12 45°	208348
	16	5/8"	30	1/2"	13	60	22	SFL3 1/2 DN 16 45°	208349
	16	5/8"	38	3/4"	13	61	23	SFL3 3/4 DN 16 45°	208350
	20	3/4"	38	3/4"	15,4	65	23	SFL3 3/4 DN 20 45°	208351
	20	3/4"	45	1"	15,4	65	23	SFL3 1 DN 20 45°	208352
	25	1"	45	1"	21,4	80	29	SFL3 1 DN 25 45°	208353
	25	1"	51	1.1/4"	21,4	80	29	SFL3 1.1/4 DN 25 45°	208354
	32	1.1/4"	51	1.1/4"	27	94	32	SFL3 1.1/4 DN 32 45°	208355
	32	1.1/4"	60	1.1/2"	27	95	34	SFL3 1.1/2 DN 32 45°	208356
	40	1.1/2"	60	1.1/2"	33,3	110	36	SFL3 1.1/2 DN 40 45°	208357
40	1.1/2"	71	2"	33,3	110	36	SFL3 2 DN 40 45°	208358	
50	2"	71	2"	40	128	41	SFL3 2 DN 50 45°	208359	
SFS6	12	1/2"	32	1/2"	9,7	51	20	SFS6 1/2 DN 12 45°	208360
	12	1/2"	41	3/4"	9,7	54	23	SFS6 3/4 DN 12 45°	208361
	16	5/8"	32	1/2"	13	61	23	SFS6 1/2 DN 16 45°	208362
	16	5/8"	41	3/4"	13	64	26	SFS6 3/4 DN 16 45°	208363
	20	3/4"	41	3/4"	15,4	67	26	SFS6 3/4 DN 20 45°	208364
	20	3/4"	48	1"	15,4	70	28	SFS6 1 DN 20 45°	208365
	25	1"	48	1"	21,4	85	34	SFS6 1 DN 25 45°	208366
	25	1"	54	1.1/4"	21,4	88	36	SFS6 1.1/4 DN 25 45°	208367
	32	1.1/4"	54	1.1/4"	27	101	40	SFS6 1.1/4 DN 32 45°	208368
	32	1.1/4"	64	1.1/2"	27	105	43	SFS6 1.1/2 DN 32 45°	208369
	40	1.1/2"	64	1.1/2"	33,3	120	46	SFS6 1.1/2 DN 40 45°	208370
	40	1.1/2"	79	2"	33,3	125	52	SFS6 2 DN 40 45°	208371
	50	2"	79	2"	40	143	57	SFS6 2 DN 50 45°	208372

* Werte können abweichend sein / Values may differ

SFL3 / SFS6 90° (Code 61 / 62 90°)

- Nippel 90°-Bogen
- mit SAE-Flansch und O-Ring Viton
- SFL3 = 3000 psi
- SFS6 = 6000 psi

- Code 61/62 Flange 90° Swept Bend Hose Tail
- with SAE Flange and Viton O-Ring
- SFL3 = 3000 psi
- SFS6 = 6000 psi

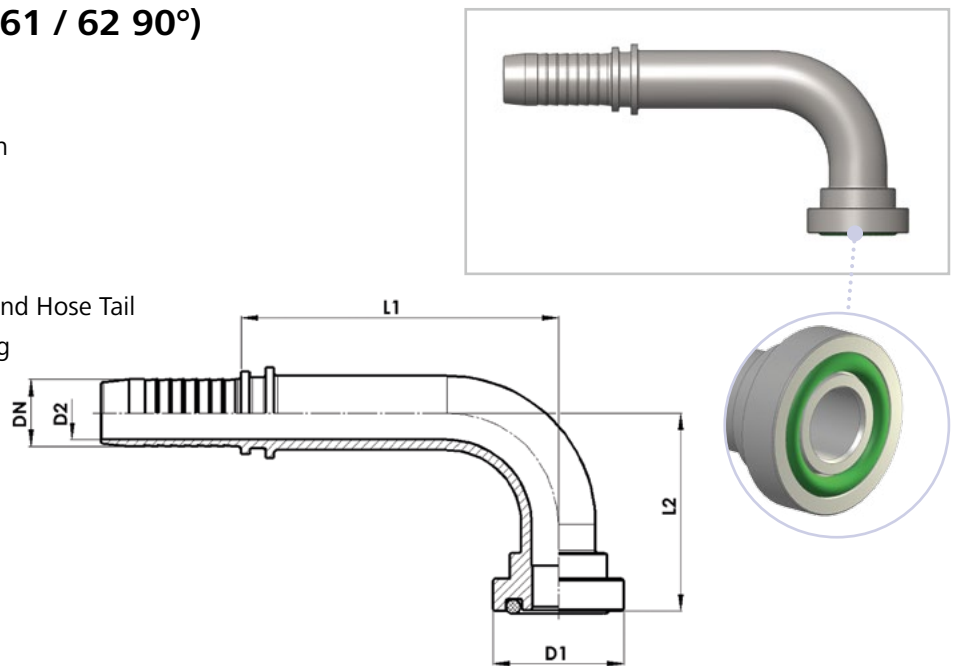

SFL3 / SFS6 90° (Code 61 / 62 90°)

Baureihe Series	Schlauch Hose		Flanschgröße Flange size		D2 mm	L1* mm	L2 mm	Bezeichnung Description	Artikel-Nr. Article No.
	DN	Ø inch	D1	inch					
SFL3	12	1/2"	30	1/2"	9,7	44	55	SFL3 1/2 DN 12 90°	208236
	12	1/2"	38	3/4"	9,7	44	60	SFL3 3/4 DN 12 90°	208324
	16	5/8"	30	1/2"	13	50	64	SFL3 1/2 DN 16 90°	208325
	16	5/8"	38	3/4"	13	50	65	SFL3 3/4 DN 16 90°	208326
	20	3/4"	38	3/4"	15,4	63	69	SFL3 3/4 DN 20 90°	208327
	20	3/4"	45	1"	15,4	63	72	SFL3 1 DN 20 90°	206730
	25	1"	45	1"	21,4	81	82	SFL3 1 DN 25 90°	208328
	25	1"	51	1.1/4"	21,4	81	84	SFL3 1 1/4 DN 25 90°	206732
	32	1.1/4"	51	1.1/4"	27	91	91	SFL3 1 1/4 DN 32 90°	208329
	32	1.1/4"	60	1.1/2"	27	91	97	SF 3 1 1/2 DN 32 90°	208330
	40	1.1/2"	60	1.1/2"	33,3	103	110	SFL3 1 1/2 DN 40 90°	208331
	40	1.1/2"	71	2"	33,3	103	116	SFL3 2 DN 40 90°	208332
50	2"	71	2"	40	122	134	SFL3 2 DN 50 90°	208333	
SFS6	12	1/2"	32	1/2"	9,7	44	56	SFS6 1/2 DN 12 90°	208334
	12	1/2"	41	3/4"	9,7	44	64	SFS6 3/4 DN 12 90°	208335
	16	5/8"	32	1/2"	13	50	61	SFS6 1/2 DN 16 90°	208336
	16	5/8"	41	3/4"	13	50	69	SFS6 3/4 DN 16 90°	208337
	20	3/4"	41	3/4"	15,4	63	73	SFS6 3/4 DN 20 90°	208338
	20	3/4"	48	1"	15,4	63	79	SFS6 1 DN 20 90°	208339
	25	1"	48	1"	21,4	81	89	SFS6 1 DN 25 90°	208340
	25	1"	54	1.1/4"	21,4	81	92	SFS6 1 1/4 DN 25 90°	208341
	32	1.1/4"	54	1.1/4"	27	91	99	SFS6 1 1/4 DN 32 90°	208342
	32	1.1/4"	64	1.1/2"	27	91	101	SFS6 1 1/2 DN 32 90°	208343
	40	1.1/2"	64	1.1/2"	33,3	103	115	SFS6 1 1/2 DN 40 90°	208344
	40	1.1/2"	79	2"	33,3	103	125	SFS6 2 DN 40 90°	208345
50	2"	79	2"	40	122	142	SFS6 2 DN 50 90°	208346	

* Werte können abweichend sein / Values may differ

RGN (Banjo Hosetail)

- Ringnippel
- Gewinde: Metrisch-zyl.

- Banjo Hose Tail
- Thread: Metric Parallel

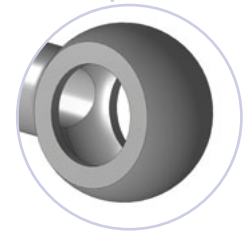
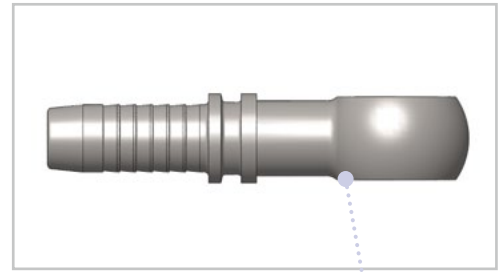
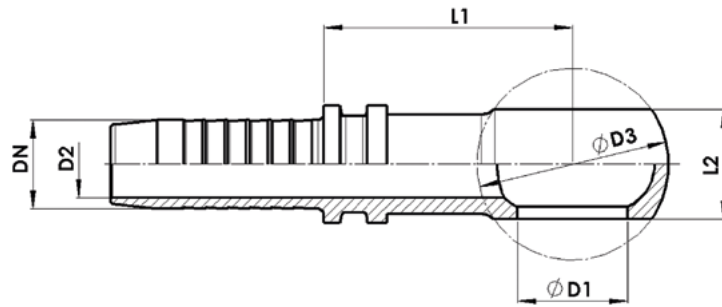

RGN (Banjo Hosetail)

Schlauch Hose		D1	D2	D3	L1	L2	passende Hohlschraube suitable Banjo Bolt	Bezeichnung Description	Artikel-Nr. Article No.
DN	Ø inch	mm	mm	mm	mm	mm			
6	1/4"	10	4,5	17	29	10	212341	RGN 10 DN 06	222771
6	1/4"	12	4,5	20	31	12	212342	RGN 12 DN 06	222431
6	1/4"	14	4,5	24	33	14	212343	RGN 14 DN 06	222432
8	5/16"	10	5,5	17	29	10	212341	RGN 10 DN 08	222772
8	5/16"	12	5,5	20	31	12	212342	RGN 12 DN 08	222773
8	5/16"	14	5,5	24	33	14	212343	RGN 14 DN 08	222433
8	5/16"	16	5,5	28	35	16	212344	RGN 16 DN 08	222434
10	3/8"	14	7,1	24	34	14	212343	RGN 14 DN 10	222435
10	3/8"	16	7,1	28	36	16	212344	RGN 16 DN 10	222436
10	3/8"	18	7,1	32	38	20	212345	RGN 18 DN 10	222438
12	1/2"	16	9,7	28	36	16	212344	RGN 16 DN 12	222442
12	1/2"	18	9,7	32	38	20	212345	RGN 18 DN 12	222774
12	1/2"	22	9,7	39	41	25	212346	RGN 22 DN 12	222444
16	5/8"	22	13	39	41	25	212346	RGN 22 DN 16	222445
20	3/4"	26	15,4	46	47	30	212347	RGN 26 DN 20	222446

- Zöllige Abmessungen auf Anfrage
- Inch sizes on enquiry

HSCH (Banjo Bolt)

DIN 7643

- Hohlschraube
- Gewinde: Metrisch-zyl.
- passend zu RGN

- Banjo Bolt
- Thread: Metric Parallel
- Suitable for RGN

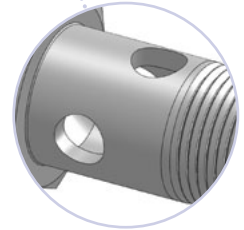
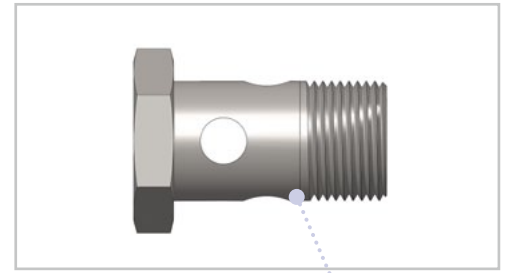
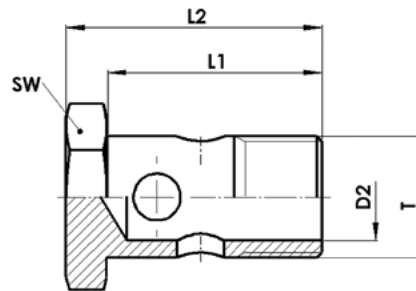
**HSCH (Banjo Bolt)**

T	D2 mm	L1* mm	L2* mm	S1 mm	passender Dichtring suitable sealing ring	Bezeichnung Description	Artikel-Nr. Article No.
M 10 x 1	5,5	19	25	14	212360	HSCH M10x1	212341
M 12 x 1,5	7	24	30	17	212361	HSCH M12x1,5	212342
M 14 x 1,5	9	26	32	19	212362	HSCH M14x1,5	212343
M 16 x 1,5	11	28	34	22	212363	HSCH M16x1,5	212344
M 18 x 1,5	13	32	38	24	212364	HSCH M18x1,5	212345
M 22 x 1,5	16	39	46	27	212365	HSCH M22x1,5	212346
M 26 x 1,5	20	45	52	32	212366	HSCH M26x1,5	212347

- Zöllige Abmessungen auf Anfrage
- Inch sizes on enquiry

DKO KÄ (Water Blaster)

- Gerader Waschgeräte-Nippel
- Water Blaster Female Hose Tail

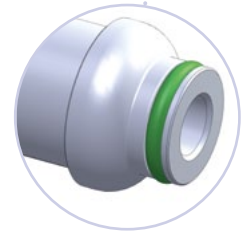
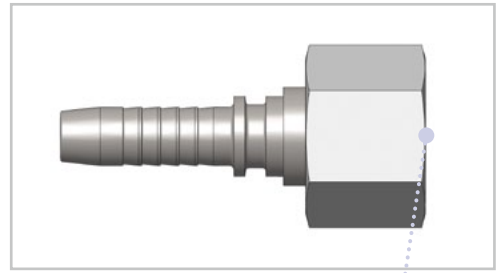
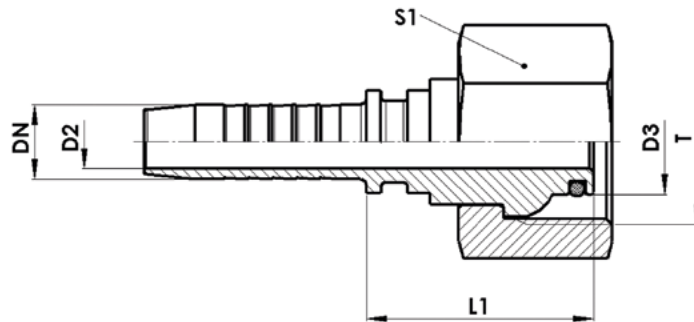

DKO KÄ (Water Blaster)

Schlauch Hose		T	D1	D2	L1	S1	Bezeichnung Description	Artikel-Nr. Article No.
DN	Ø inch		mm	mm	mm	mm		
6	1/4"	M 22 x 1,5	14	4,5	33	27	DKO KÄ DN 06	208237
8	5/16"	M 22 x 1,5	14	5,5	33	27	DKO KÄ DN 08	208285
10	3/8"	M 22 x 1,5	14	7,1	31	27	DKO KÄ DN 10	208286
12	1/2"	M 22 x 1,5	14	9,7	30	27	DKO KÄ DN 12	208287

Schlaucharmaturen Hose Fittings

Interlock

Interlock Serie mit Ausreißsicherung

Interlock Series with wiretrap

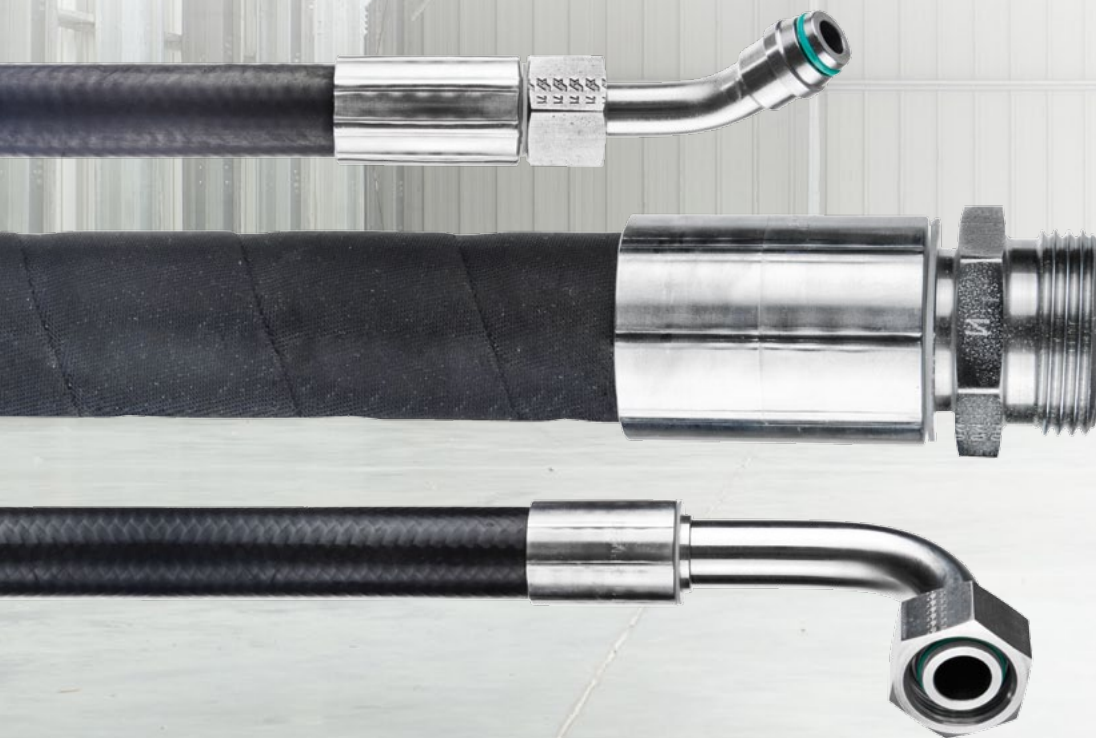

Übersicht Visual Index

DKO - IN
(DKO Interlock)

Seite [page 74](#)

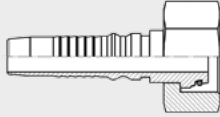

DKO 45° - IN
(DKO Interlock 45°)

Seite [page 75](#)

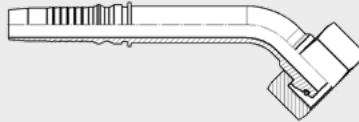

DKO 90° - IN
(DKO Interlock 90°)

Seite [page 76](#)

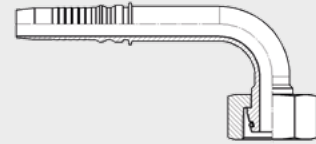

DKR - IN
(BSPP Female Interlock)

Seite [page 77](#)



DKR 45° - IN
(BSPP Female Interlock 45°)

Seite [page 78](#)

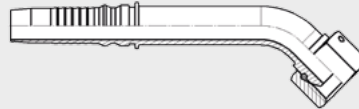

DKR 90° - IN
(BSPP Female Interlock 90°)

Seite [page 79](#)

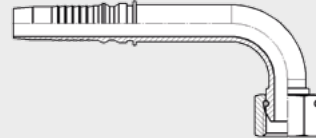

AGR - IN
(BSPP Interlock)

Seite [page 80](#)



AGR 45° - IN
(BSPP Interlock 45°)

Seite [page 81](#)



AGR 90° - IN
(BSPP Interlock 90°)

Seite [page 82](#)

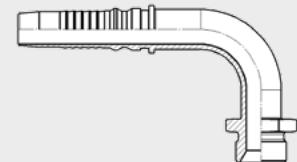

SFL3 / SFS6 - IN
(Code 61 / 62 Interlock)

Seite [page 83](#)



SFL3 / SFS6 45° - IN
(Code 61 / 62 Interlock 45°)

Seite [page 84](#)

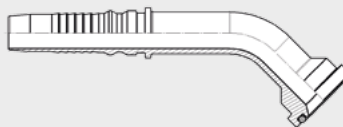

SFL3 / SFS6 90° - IN
(Code 61 / 62 Interlock 90°)

Seite [page 85](#)

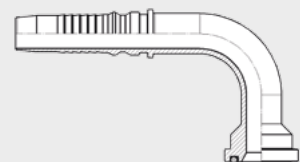

DKO - IN (DKO Interlock)

- Gerader Nippel mit Ausreißsicherung
- mit 24° DKO-Dichtkegel und O-Ring Viton
- S-Reihe
- Gewinde: Metrisch-Zyl.

- Straight Female Interlock Hose Tail
- with 24° Sealing Cone and Viton O-Ring
- S Series
- Thread: Metric Parallel

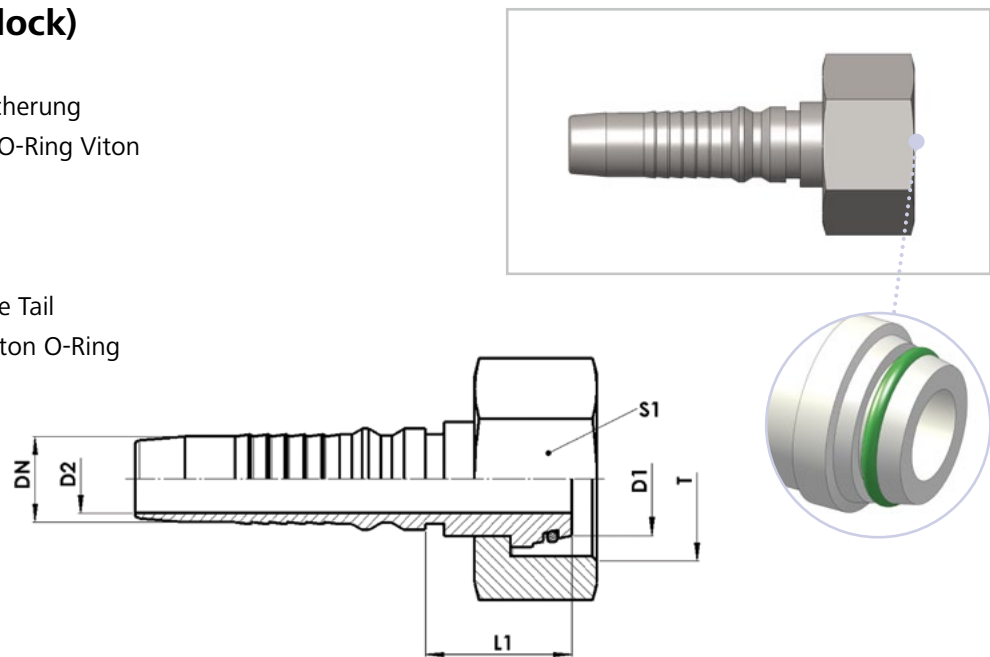

DKO - IN (DKO Interlock)

Baureihe Series	Schlauch Hose	T	D1	D2	L1	S1	Bezeichnung Description	Artikel-Nr. Article No.
	DN Ø inch		mm	mm	mm	mm		
S	20 3/4"	M 30 x 2	20	15	22	36	DKO 20S DN 20 - IN	200637
	20 3/4"	M 36 x 2	25	15	28	46	DKO 25S DN 20 - IN	200361
	25 1"	M 36 x 2	25	19	22	46	DKO 25S DN 25 - IN	200633
	25 1"	M 42 x 2	30	19	33	50	DKO 30S DN 25 - IN	200362
	32 1.1/4"	M 52 x 2	38	25	36	60	DKO 38S DN 32 - IN	200363

DKO 45° - IN (DKO Interlock 45°)

- Nippel 45°-Bogen mit Ausreißsicherung
- mit 24° DKO-Dichtkegel und O-Ring Viton
- S-Reihe
- Gewinde: Metrisch-Zyl.

- Female 45° Swept Bend Interlock Hose Tail
- with 24° Sealing Cone and Viton O-Ring
- S Series
- Thread: Metric Parallel

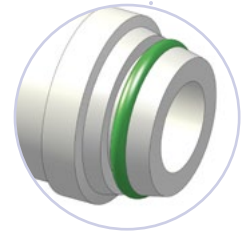
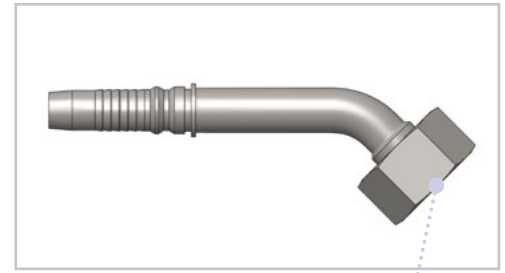
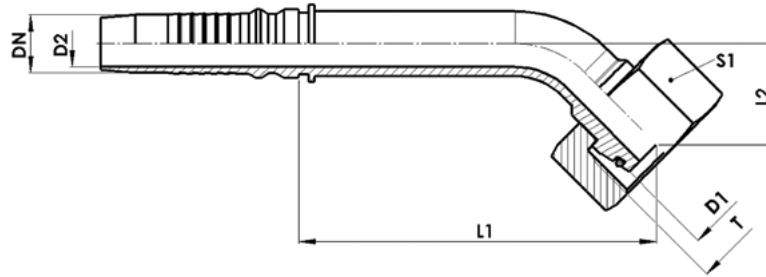

DKO 45° - IN (DKO Interlock 45°)

Baureihe Series	Schlauch Hose	T	D1	D2	L1*	L2*	S1	Bezeichnung Description	Artikel-Nr. Article No.
	DN Ø inch		mm	mm	mm	mm	mm		
S	20 3/4"	M 30 x 2	20	15	72	30	36	DKO 20S DN 20 45° - IN	208108
	20 3/4"	M 36 x 2	25	15	75	33	46	DKO 25S DN 20 45° - IN	204338
	25 1"	M 36 x 2	25	19	87	36	46	DKO 25S DN 25 45° - IN	208109
	25 1"	M 42 x 2	30	19	95	44	50	DKO 30S DN 25 45° - IN	208110
	32 1.1/4"	M 52 x 2	38	25	109	47	60	DKO 38S DN 32 45° - IN	208111

* Werte können abweichend sein / Values may differ

DKO 90° - IN (DKO Interlock 90°)

- Nippel 90°-Bogen mit Ausreißsicherung
- mit 24° DKO-Dichtkegel und O-Ring Viton
- S-Reihe
- Gewinde: Metrisch-Zyl.

- Female 90° Swept Bend Interlock Hose Tail
- with 24° Sealing Cone and Viton O-Ring
- S Series
- Thread: Metric Parallel

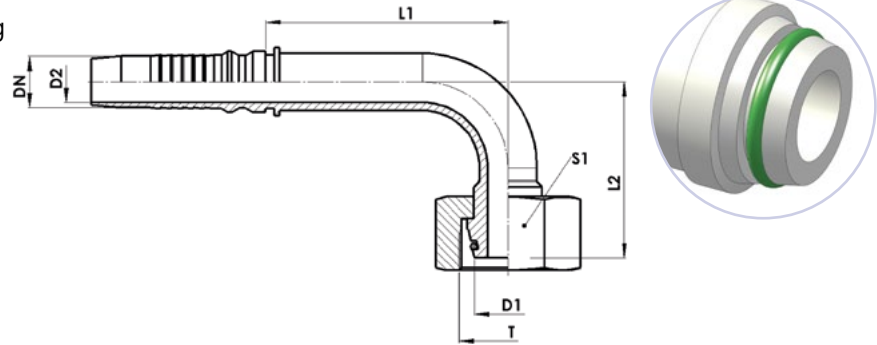

DKO 90° - IN (DKO Interlock 90°)

Baureihe Series	Schlauch Hose		T	D1	D2	L1*	L2*	S1	Bezeichnung Description	Artikel-Nr. Article No.
	DN	Ø inch								
S	20	3/4"	M 30 x 2	20	15	60	68	36	DKO 20S DN 20 90° - IN	208117
	20	3/4"	M 36 x 2	25	15	70	67	46	DKO 25S DN 20 90° - IN	200364
	25	1"	M 36 x 2	25	19	78	76	46	DKO 25S DN 25 90° - IN	200635
	25	1"	M 42 x 2	30	19	78	85	50	DKO 30S DN 25 90° - IN	200365
	32	1.1/4"	M 52 x 2	38	25	89	98	60	DKO 38S DN 32 90° - IN	200366

* Werte können abweichend sein / Values may differ

DKR - IN (BSPP Female Interlock)

- Gerader Nippel mit Ausreißsicherung
- mit 60°-Dichtkegel
- S-Reihe
- Gewinde: BSPP

- BSPP Female Interlock Hose Tail
- with 60° Swivel
- S Series
- Thread: BSPP

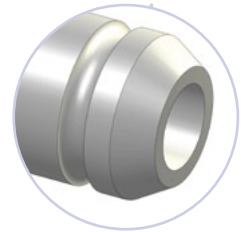
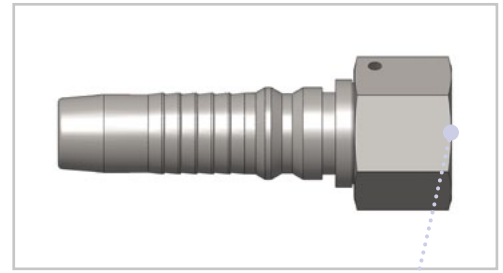
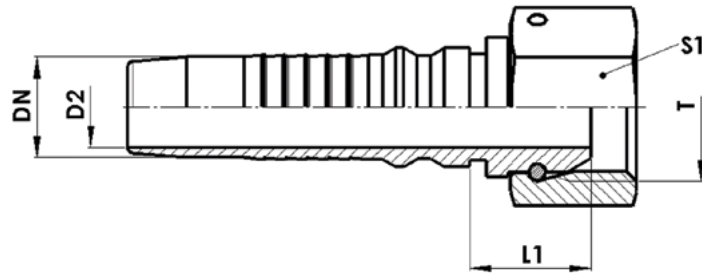

DKR - IN (BSPP Female Interlock)

Schlauch Hose		T	D2	L1	S1	Bezeichnung Description	Artikel-Nr. Article No.
DN	Ø inch		mm	mm	mm		
20	3/4"	G 3/4"	15,4	23	32	DKR 3/4 DN 20 - IN	200356
25	1"	G 1"	21,4	23	41	DKR 1 DN 25 - IN	200357
32	1.1/4"	G 1.1/4"	27	28	50	DKR 1 1/4 DN 32 - IN	208127
40	1.1/2"	G 1.1/2"	33,3	27	55	DKR 1 1/2 DN 40 - IN	200359
50	2"	G 2"	40	32	70	DKR 2 DN 50 - IN	200360

DKR 45° - IN (BSPP Female Interlock 45°)

- Nippel 45°-Bogen mit Ausreißsicherung
- mit 60°-Dichtkegel
- S-Reihe
- Gewinde: BSPP

- BSPP Female 45° Swept Bend Interlock Hose Tail
- with 60° Swivel
- S Series
- Thread: BSPP

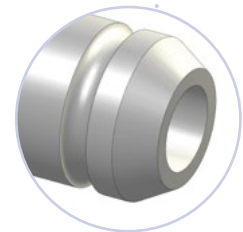
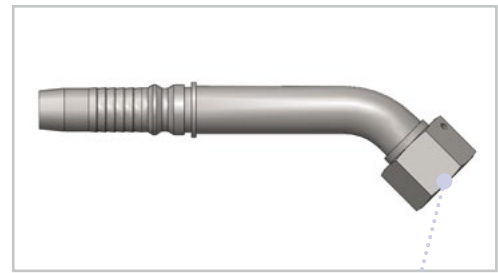
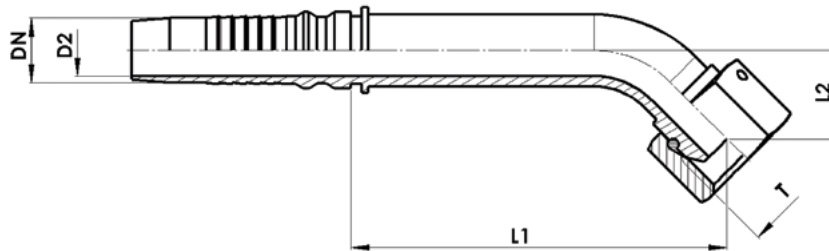

DKR 45° - IN (BSPP Female Interlock 45°)

Schlauch Hose		T	D2	L1*	L2*	S1	Bezeichnung Description	Artikel-Nr. Article No.
DN	Ø inch		mm	mm	mm	mm		
20	3/4"	G 3/4"	15,4	68	26	32	DKR 3/4 DN 20 45° - IN	208128
25	1"	G 1"	21,4	83	32	41	DKR 1 DN 25 45° - IN	208129
32	1.1/4"	G 1.1/4"	27	99	37	50	DKR 1.1/4 DN 32 45° - IN	208130
40	1.1/2"	G 1.1/2"	33,3	114	40	55	DKR 1.1/2 DN 40 45° - IN	208131
50	2"	G 2"	40	133	47	70	DKR 2 DN 50 45° - IN	208132

* Werte können abweichend sein / Values may differ

DKR 90° - IN (BSPP Female Interlock 90°)

- Nippel 90°-Bogen mit Ausreißsicherung
- mit 60°-Dichtkegel
- S-Reihe
- Gewinde: BSPP

- BSPP Female 90° Swept Bend Interlock Hose Tail
- with 60° Swivel
- S Series
- Thread: BSPP

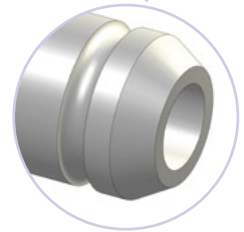
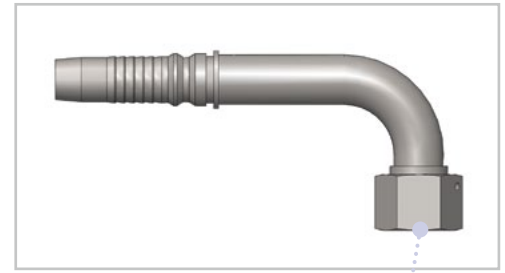
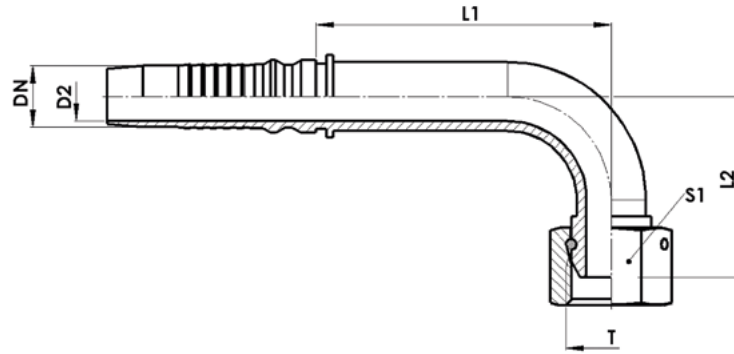

DKR 90° - IN (BSPP Female Interlock 90°)

Schlauch Hose		T	D2	L1*	L2*	S1	Bezeichnung Description	Artikel-Nr. Article No.
DN	Ø inch		mm	mm	mm	mm		
20	3/4"	G 3/4"	15,4	60	58	32	DKR 3/4 DN 20 90° - IN	200367
25	1"	G 1"	21,4	78	71	41	DKR 1 DN 25 90° - IN	200368
32	1.1/4"	G 1.1/4"	27	89	84	50	DKR 1.1/4 DN 32 90° - IN	200369
40	1.1/2"	G 1.1/2"	33,3	100	102	55	DKR 1.1/2 DN 40 90° - IN	200370
50	2"	G 2"	40	119	125	70	DKR 2 DN 50 90° - IN	200371

* Werte können abweichend sein / Values may differ

AGR - IN (BSPP Interlock)

- Gerader Nippel mit Ausreißsicherung
- mit 60°-Dichtkegel
- Gewinde: BSPP

- BSPP Male Interlock Hose Tail
- with 60° Swivel
- Thread: BSPP

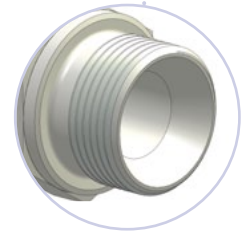
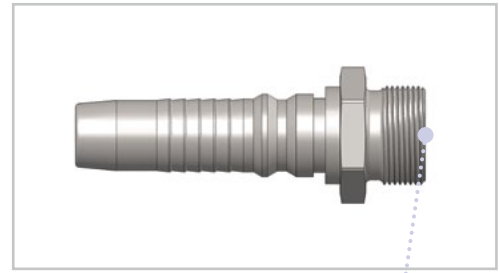
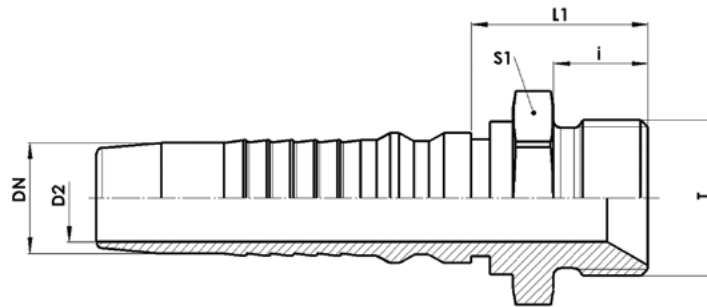

AGR - IN (BSPP Interlock)

Schlauch Hose		T	D2	L1	S1	i	Bezeichnung Description	Artikel-Nr. Article No.
DN	Ø inch		mm	mm	mm	mm		
20	3/4"	G 3/4"	15	27	32	16	AGR 3/4 DN 20 - IN	118067
25	1"	G 1"	19	36	41	18	AGR 1 DN 25 - IN	118068
32	1.1/4"	G 1.1/4"	25	40	46	20	AGR 1 1/4 DN 32 - IN	118069
40	1.1/2"	G 1.1/2"	29	44	55	22	AGR 1 1/2 DN 40 - IN	118070
50	2"	G 2"	40	44	70	24	AGR 2 DN 50 - IN	118071

AGR 45° - IN (BSPP Interlock 45°)

- Nippel 45°-Bogen mit Ausreißsicherung
- mit 60°-Dichtkegel
- Gewinde: BSPP

- BSPP 45° Male Interlock Hose Tail
- with 60° Swivel
- Thread: BSPP

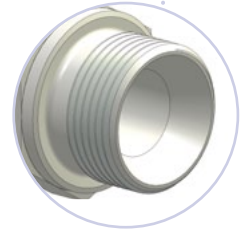
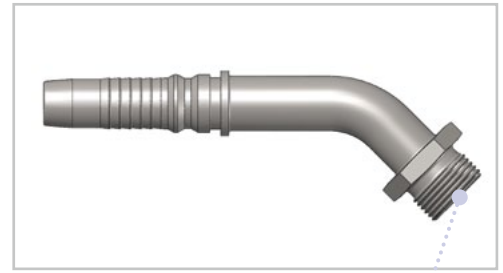
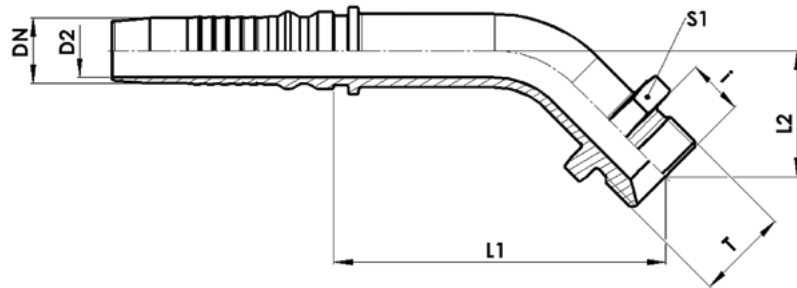

AGR 45° - IN (BSPP Interlock 45°)

Schlauch Hose		T	D2	L1*	L2*	S1	i	Bezeichnung Description	Artikel-Nr. Article No.
DN	Ø inch		mm	mm	mm	mm	mm		
20	3/4"	G 3/4"	15,4	72	31	32	16	AGR 3/4 DN 20 45° - IN	208158
25	1"	G 1"	21,4	93	42	41	18	AGR 1 DN 25 45° - IN	208164
32	1.1/4"	G 1.1/4"	27	109	47	46	20	AGR 1.1/4 DN 32 45° - IN	208165
40	1.1/2"	G 1.1/2"	33,3	127	53	55	22	AGR 1.1/2 DN 40 45° - IN	208166
50	2"	G 2"	40	144	58	70	24	AGR 2 DN 50 45° - IN	208167

* Werte können abweichend sein / Values may differ

AGR 90° - IN (BSPP Interlock 90°)

- Nippel 90°-Bogen mit Ausreißsicherung
- mit 60°-Dichtkegel
- Gewinde: BSPP

- BSPP 90° Male Interlock Hose Tail
- with 60° Swivel
- Thread: BSPP

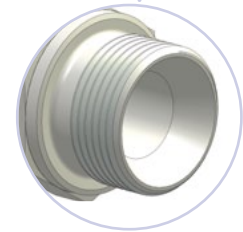
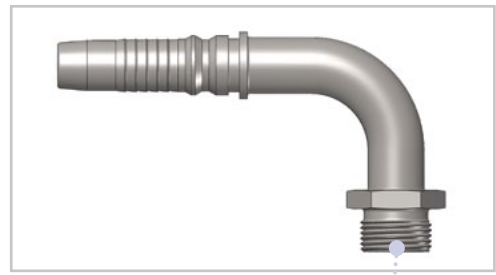
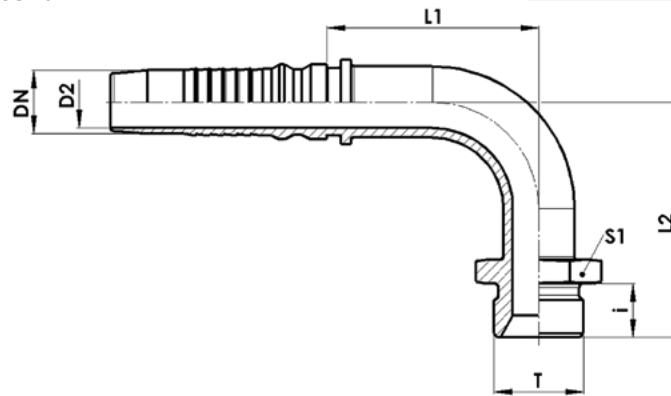

AGR 90° - IN (BSPP Interlock 90°)

Schlauch Hose		T	D2	L1*	L2*	S1	i	Bezeichnung Description	Artikel-Nr. Article No.
DN	Ø inch		mm	mm	mm	mm	mm		
20	3/4"	G 3/4"	15,4	60	62	32	32	AGR 3/4 DN 20 90° - IN	208974
25	1"	G 1"	21,4	76	84	41	41	AGR 1 DN 25 90° - IN	208975
32	1.1/4"	G 1.1/4"	27	88	98	46	46	AGR 1.1/4 DN 32 90° - IN	208976
40	1.1/2"	G 1.1/2"	33,3	98	119	55	55	AGR 1.1/2 DN 40 90° - IN	208977
50	2"	G 2"	40	119	165	70	70	AGR 2 DN 50 90° - IN	208978

* Werte können abweichend sein / Values may differ

SFL3 / SFS6 - IN (Code 61 / 62 Interlock)

- Gerader Nippel mit Ausreißsicherung
- mit SAE-Flansch und O-Ring Viton
- SFL3 = 3000 psi
- SFS6 = 6000 psi

- Code 61/62 Flange Interlock Hose Tail
- with SAE Flange and Viton O-Ring
- SFL3 = 3000 psi
- SFS6 = 6000 psi

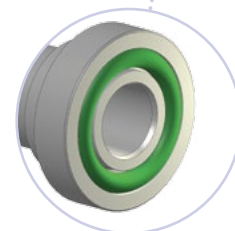
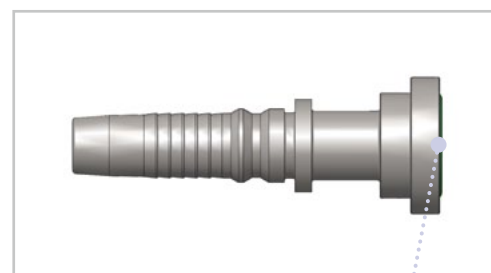
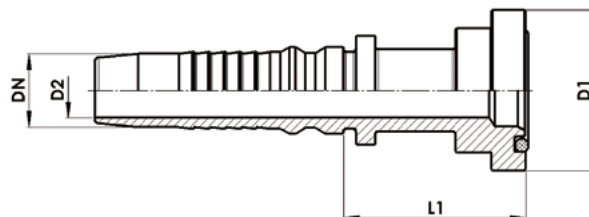
**SFL3 / SFS6 - IN (Code 61 / 62 Interlock)**

Baureihe Series	Schlauch Hose		Flanschgröße Flange size		D2 mm	L1 mm	Bezeichnung Description	Artikel-Nr. Article No.
	DN	Ø inch	D1	inch				
SFL3	20	3/4"	38	3/4"	14	44	SFL3 3/4" DN 20 - IN	208241
	25	1"	44	1"	19	45	SFL3 1" DN 25 - IN	208243
	32	1.1/4"	51	1.1/4"	25	64	SFL3 1 1/4" DN 32 - IN	208244
	40	1.1/2"	60	1.1/2"	32	54	SFL3 1 1/2" DN 40 - IN	208245
	50	2"	71	2"	40	65	SFL3 2" DN 50 - IN	208246
SFS6	20	3/4"	41	3/4"	14	44	SFS6 3/4" DN 20 - IN	208247
	20	3/4"	48	1"	14	44	SFS6 1" DN 20 - IN	208248
	25	1"	48	1"	19	44	SFS6 1" DN 25 - IN	208249
	25	1"	54	1.1/4"	19	45	SFS6 1.1/4" DN 25 - IN	208250
	32	1.1/4"	54	1.1/4"	25	64	SFS6 1.1/4" DN 32 - IN	208251
	40	1.1/2"	54	1.1/4"	32	54	SFS6 1.1/4" DN 40 - IN	208252
	40	1.1/2"	64	1.1/2"	32	54	SFS6 1 1/2" DN 40 - IN	208254
	40	1.1/2"	79	2"	32	54	SFS6 2" DN 40 - IN	208255
50	2"	79	2"	40	65	SFS6 2" DN 50 - IN	208257	

SFL3 / SFS6 45° - IN (Code 61 / 62 Interlock 45°)

- Nippel 45°-Bogen mit Ausreißsicherung
- mit SAE-Flansch und O-Ring Viton
- SFL3 = 3000 psi
- SFS6 = 6000 psi

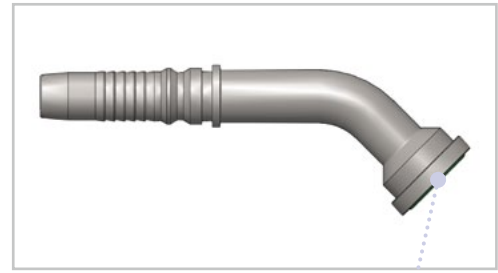

- Code 61/62 Flange 45° Swept Bend Interlock Hose Tail
- with SAE Flange and Viton O-Ring
- SFL3 = 3000 psi
- SFS6 = 6000 psi

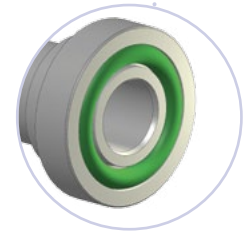
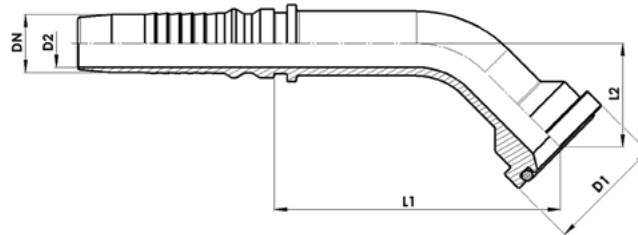
**SFL3 / SFS6 45° - IN (Code 61 / 62 Interlock 45°)**

Baureihe Series	Schlauch Hose		Flanschgröße Flange size		D2 mm	L1* mm	L2* mm	Bezeichnung Description	Artikel-Nr. Article No.
	DN	Ø inch	D1	inch					
SFL3	20	3/4"	38	3/4"	15,4	66	23	SFL3 3/4 DN 20 45° - IN	208239
	25	1"	45	1"	21,4	80	29	SFL3 1 DN 25 45° - IN	208398
	32	1.1/4"	51	1.1/4"	27	93	32	SFL3 1 1/4 DN 32 45° - IN	208399
	40	1.1/2"	60	1.1/2"	33,3	109	36	SFL3 1 1/2 DN 40 45° - IN	208400
	50	2"	71	2"	40	127	41	SFL3 2 DN 50 45° - IN	208401
SFS6	20	3/4"	41	3/4"	15,4	69	26	SFS6 3/4 DN 20 45° - IN	208402
	20	3/4"	48	1"	15,4	71	28	SFS6 1 DN 20 45° - IN	208403
	25	1"	48	1"	21,4	85	36	SFS6 1 DN 25 45° - IN	208404
	25	1"	54	1.1/4"	21,4	88	37	SFS6 1 1/4 DN 25 45° - IN	208405
	32	1.1/4"	54	1.1/4"	27	101	40	SFS6 1 1/4 DN 32 45° - IN	208406
	40	1.1/2"	64	1.1/4"	33,3	115	43	SFS6 1 1/4 DN 40 45° - IN	208407
	40	1.1/2"	64	1.1/2"	33,3	119	46	SFS6 1 1/2 DN 40 45° - IN	208408
	40	1.1/2"	79	2"	33,3	124	52	SFS6 2 DN 40 45° - IN	208409
	50	2"	79	2"	40	142	57	SFS6 2 DN 50 45° - IN	208410

* Werte können abweichend sein / Values may differ

SFL3 / SFS6 90° - IN (Code 61 / 62 Interlock 90°)

- Nippel 90°-Bogen mit Ausreißsicherung
- mit SAE-Flansch und O-Ring Viton
- SFL3 = 3000 psi
- SFS6 = 6000 psi

- Code 61/62 Flange 90° Swept Bend Interlock Hose Tail
- with SAE Flange and Viton O-Ring
- SFL3 = 3000 psi
- SFS6 = 6000 psi

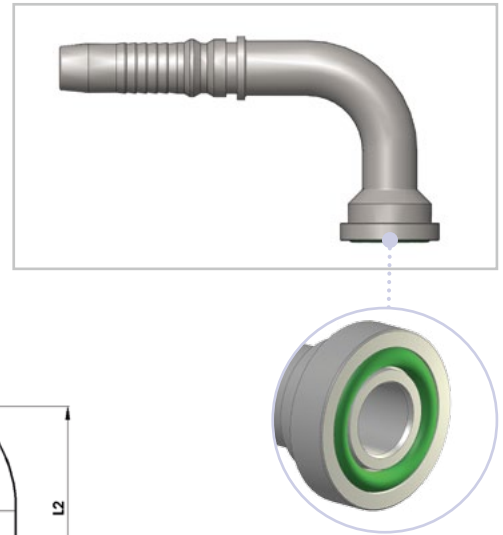
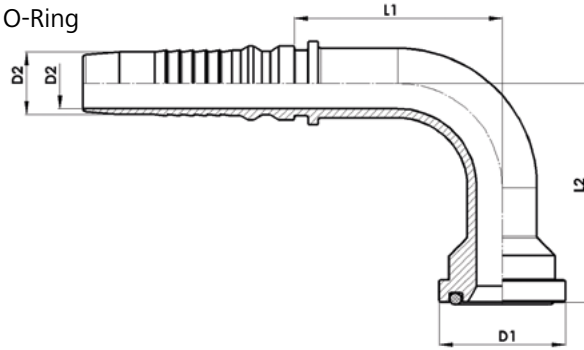

SFL3 / SFS6 90° - IN (Code 61 / 62 Interlock 90°)

Baureihe Series	Schlauch Hose		Flanschgröße Flange size		D2 mm	L1* mm	L2* mm	Bezeichnung Description	Artikel-Nr. Article No.
	DN	Ø inch	D1	inch					
SFL3	20	3/4"	38	3/4"	15,4	84	59	SFL3 3/4 DN 20 90° - IN	208240
	25	1"	45	1"	21,4	93	72	SFL3 1 DN 25 90° - IN	208411
	32	1.1/4"	51	1.1/4"	27	121	81	SFL3 1 1/4 DN 32 90° - IN	208412
	40	1.1/2"	60	1.1/2"	33,3	133	100	SFL3 1 1/2 DN 40 90° - IN	208413
	50	2"	71	2"	40	152	124	SFL3 2 DN 50 90° - IN	208414
SFS6	20	3/4"	41	3/4"	15,4	84	63	SFS6 3/4 DN 20 90° - IN	208415
	20	3/4"	48	1"	15,4	84	69	SFS6 1 DN 20 90° - IN	208416
	25	1"	48	1"	21,4	93	79	SFS6 1 DN 25 90° - IN	208417
	25	1"	54	1.1/4"	21,4	93	83	SFS6 1 1/4 DN 25 90° - IN	208418
	32	1.1/4"	54	1.1/4"	27	121	90	SFS6 1 1/4 DN 32 90° - IN	208419
	40	1.1/2"	64	1.1/4"	33,3	133	103	SFS6 1 1/4 DN 40 90° - IN	208420
	40	1.1/2"	64	1.1/2"	33,3	133	105	SFS6 1 1/2 DN 40 90° - IN	208421
	40	1.1/2"	79	2"	33,3	133	115	SFS6 2 DN 40 90° - IN	208422
50	2"	79	2"	40	152	132	SFS6 2 DN 50 90° - IN	208423	

* Werte können abweichend sein / Values may differ

Pressfassungen Ferrules



Übersichtstabelle

Pressfassungen und Schläuche

no skive = Schlauch nicht geschält

skive1 = Schlauch außen geschält

skive2 = Schlauch außen und innen geschält









Product overview







Ferrules and hoses

no skive = Hose non skive

skive1 = Hose external skive

skive2 = Hose external and internal skive

Schlauchtyp Hose-type			Schlauch-Typ Hose-type							
										
DN	Größe size	ø-innen ID	2 TE-EN 854	3 TE-EN 854	1 ST-EN 853	2 ST-EN 853	1 SN-EN 853	2 SN-EN 853	1 SC-EN 857	2 SC-EN 857
			no skive	no skive	skive 1	skive 1	no skive	no skive	no skive	no skive
05	03	3/16"	-	-	200715	200726	-	-	-	-
06	04	1/4"	200762	200762	200716	200727	200747	200747	221730	200747
08	05	5/16"	200763	200763	200717	200728	200748	200748	221733	200748
10	06	3/8"	200764	200764	200718	200729	200749	200749	221418	200749
12	08	1/2"	200766	200766	200719	200730	200750	200750	221735	200750
16	10	5/8"	200767	200767	200720	200732	200752	200752	221419	200752
20	12	3/4"	200768	200768	200721	200741	200753	200753	221736	200753
25	16	1"	200769	200769	200722	200742	200754	200754	221737	200754
32	20	1.1/4"	-	200770	200723	200743	200755	200759	-	-
40	24	1.1/2"	-	200771	200724	200744	200756	200760	-	-
50	32	2"	-	200745	200725	200745	200757	200761	-	-

Schlauchtyp Hose-type			Schlauch-Typ Hose-type						
									
DN	Größe size	ø-innen ID	R 7 - EN 855 SAE 100 R7	Teflon- schlauch T1	Teflon-Well- schlauch W1	4 SP-EN 856	4 SH-EN 856 Interlock	R 13-EN 856 Interlock	SAE 100 R 15 Interlock
			no skive	no skive	no skive	skive 1	skive 2	skive 2	skive 2
05	03	3/16"	200795	200787	-	-	-	-	-
06	04	1/4"	200796	200788	200812	200772	-	-	-
08	05	5/16"	200797	200789	-	-	-	-	-
10	06	3/8"	200798	200790	200813	200773	-	-	-
12	08	1/2"	209679	200791	200814	200774	-	-	-
16	10	5/8"	209680	200792	200815	200775	-	-	-
20	12	3/4"	209681	200793	200021	200776	114471	114471	114471
25	16	1"	209682	200794	200802	200777	114472	114472	114472
32	20	1.1/4"	-	-	200816	200778	114463	114469	114469
40	24	1.1/2"	-	-	208168	200779	114464	114470	114470
50	32	2"	-	-	208169	200780	114465	114473	-

2 TE - EN 854
(1 Fabric Braid Hose)
no skive

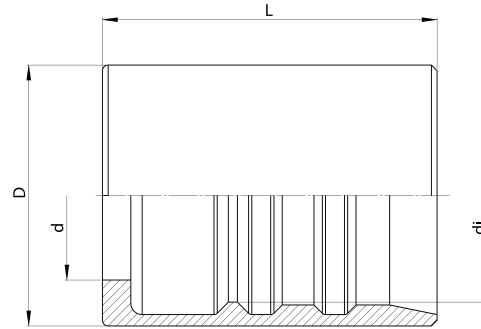
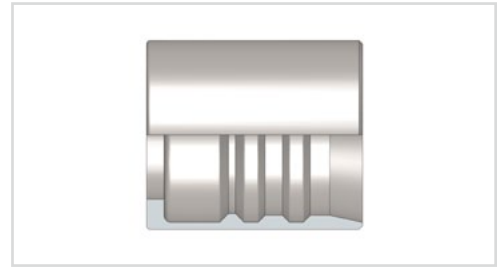

2 TE - EN 854 (1 Fabric Braid Hose) no skive

DN	Größe Size	ø-innen ID	D mm	d mm	di mm	L mm	Bezeichnung Description	Artikel-Nr. Article No.
6	1/4"		19	11,1	14,8	28	PF 4 DN06	200762
8	5/16"		21	13,5	17,2	28	PF 4 DN08	200763
10	3/8"		23	14,9	18,8	29,5	PF 4 DN10	200764
12	1/2"		27	18,4	22,5	31	PF 4 DN12	200766
16	5/8"		32	21,8	26,5	33	PF 4 DN16	200767
20	3/4"		35	24,5	29,5	37,5	PF 4 DN20	200768
25	1"		42	30,8	36,8	45,5	PF 4 DN25	200769

3 TE - EN 854 (2 Fabric Braid Hose) no skive

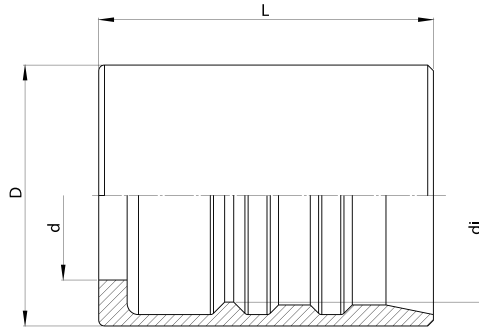
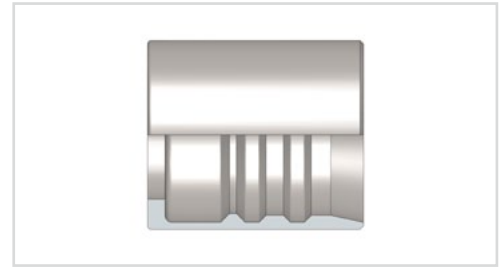

3 TE - EN 854 (2 Fabric Braid Hose) no skive

DN	Größe Size	ø-innen ID	D mm	d mm	di mm	L mm	Bezeichnung Description	Artikel-Nr. Article No.
6		1/4"	19	11,1	14,8	28	PF 4 DN06	200762
8		5/16"	21	13,5	17,2	28	PF 4 DN08	200763
10		3/8"	23	14,9	18,8	29,5	PF 4 DN10	200764
12		1/2"	27	18,4	22,5	31	PF 4 DN12	200766
16		5/8"	32	21,8	26,5	33	PF 4 DN16	200767
20		3/4"	35	24,5	29,5	37,5	PF 4 DN20	200768
25		1"	42	30,8	36,8	45,5	PF 4 DN25	200769
32		1.1/4"	48	37,8	43,6	55	PF 4 DN32	200770
40		1.1/2"	57,2	44,2	51	63,2	PF 4 DN40	200771

1 ST - EN 853 - SAE 100 R1A
(1 Wire Skive Hose)
skive1

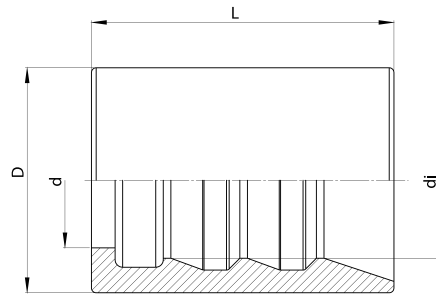
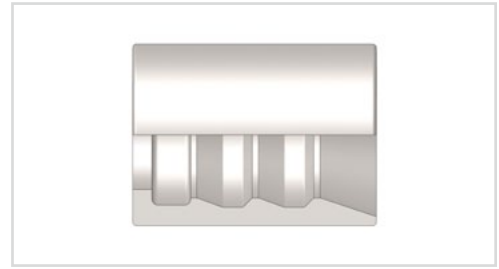

1 ST - EN 853 - SAE 100 R1A (1 Wire Skive Hose) skive1

DN	Größe Size	ø-innen ø-inside "	D mm	d mm	di mm	L mm	Bezeichnung Description	Artikel-Nr. Article no.
5		3/16"	17,5	8,7	11,2	27,5	PF 1 DN05	200715
6		1/4"	20,6	11,5	13,2	30,5	PF 1 DN06	200716
8		5/16"	20,6	12,7	14,2	30,5	PF 1 DN08	200717
10		3/8"	23,8	14,3	16,5	32	PF 1 DN10	200718
12		1/2"	28,6	18,6	20,9	34	PF 1 DN12	200719
16		5/8"	31,8	21,8	24	37	PF 1 DN16	200720
20		3/4"	36,5	24,6	27,8	42,6	PF 1 DN20	200721
25		1"	42,9	30,5	34,6	50,8	PF 1 DN25	200722
32		1.1/4"	50,7	37,8	41,6	59	PF 1 DN32	200723
40		1.1/2"	57,2	44,2	48	63,3	PF 1 DN40	200724
50		2"	71,4	56,8	62	78,8	PF 1 DN50	200725

2 ST - EN 853 - SAE 100 R2A (2 Wire Skive Hose) skive1

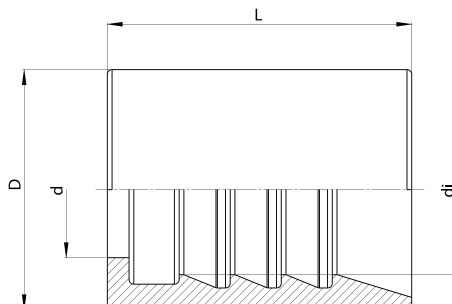
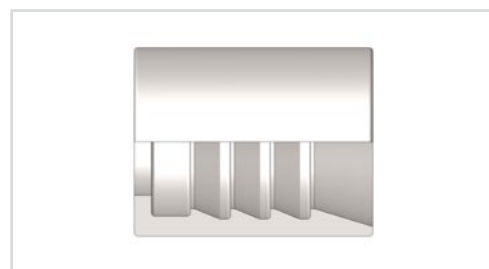

2 ST - EN 853 - SAE 100 R2A (2 Wire Skive Hose) skive1

DN	Größe Size	ø-innen ø-inside "	D mm	d mm	di mm	L mm	Bezeichnung Description	Artikel-Nr. Article no.
5		3/16"	19	8,8	12,4	27,6	PF 2 DN05	200726
6		1/4"	20,5	11	14,2	30,7	PF 2 DN06	200727
8		5/16"	22,2	12,7	15,9	30,5	PF 2 DN08	200728
10		3/8"	25,4	14,4	18	32,2	PF 2 DN10	200729
12		1/2"	30	18,5	22,1	34,5	PF 2 DN12	200730
16		5/8"	33,3	21,8	25,6	36,9	PF 2 DN16	200732
20		3/4"	38	24,5	29,4	43	PF 2 DN20	200741
25		1"	46	31	37	50,9	PF 2 DN25	200742
32		1.1/4"	55,5	37,6	45,3	59	PF 2 DN32	200743
40		1.1/2"	62	44	51,9	63,5	PF 2 DN40	200744
50		2"	76,3	57,2	65	79	PF 2 DN50	200745

**1 SN - EN 853 - SAE 100 R1AT
(1 Wire Non Skive Hose)
no skive**

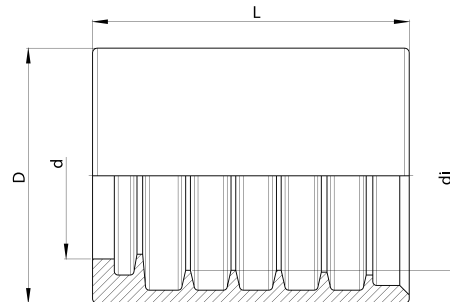
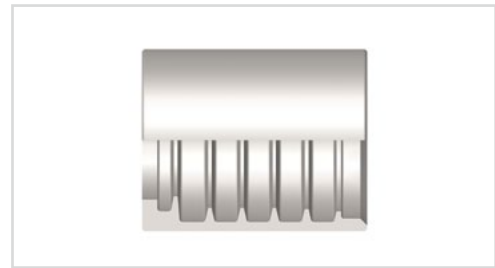

1 SN - EN 853 - SAE 100 R1AT (1 Wire Non Skive Hose) no skive

DN	Größe Size	ø-innen ø-inside "	D mm	d mm	di mm	L mm	Bezeichnung Description	Artikel-Nr. Article no.
6		1/4"	23	13,2	16	30,6	PF 3 DN06	200747
8		5/16"	24	13,8	17,8	30,6	PF 3 DN08	200748
10		3/8"	27	17,6	20	33,5	PF 3 DN10	200749
12		1/2"	30	20,3	23,4	34,7	PF 3 DN12	200750
16		5/8"	34	23,3	26,7	36,8	PF 3 DN16	200752
20		3/4"	38	27,4	30,5	42,2	PF 3 DN20	200753
25		1"	48	34,4	39,3	48,3	PF 3 DN25	200754
32		1.1/4"	54	38,9	45,5	59	PF 3 DN32	200755
40		1.1/2"	62	45,3	52,7	62,5	PF 3 DN40	200756
50		2"	76	57,7	67	78,8	PF 3 DN50	200757

2 SN - EN 853 - SAE 100 R2AT (2 Wire Non Skive Hose) no skive

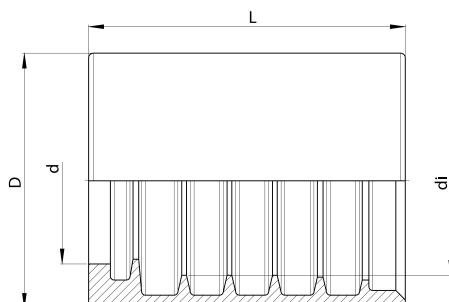
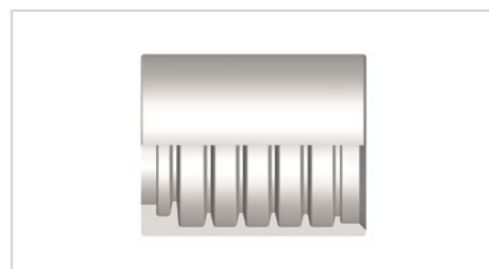

2 SN - EN 853 - SAE 100 R2AT (2 Wire Non Skive Hose) no skive

DN	Größe Size	ø-innen ø-inside "	D mm	d mm	di mm	L mm	Bezeichnung Description	Artikel-Nr. Article no.
6		1/4"	23	13,2	16	30,6	PF 3 DN06	200747
8		5/16"	24	13,8	17,8	30,6	PF 3 DN08	200748
10		3/8"	27	17,6	20	33,5	PF 3 DN10	200749
12		1/2"	30	20,3	23,4	34,7	PF 3 DN12	200750
16		5/8"	34	23,3	26,7	36,8	PF 3 DN16	200752
20		3/4"	38	27,4	30,5	42,2	PF 3 DN20	200753
25		1"	48	34,4	39,3	48,3	PF 3 DN25	200754
32		1.1/4"	58,8	38,8	50	59,3	PF 11 DN32	200759
40		1.1/2"	66,8	45,6	56,4	62,7	PF 11 DN40	200760
50		2"	79,4	57,7	68,5	78,8	PF 11 DN50	200761

**1 SC - EN 857 - ISO 11237-1 1SC
(1 Wire Compact Non Skive Hose)
no skive**

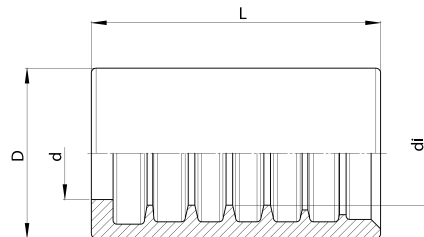
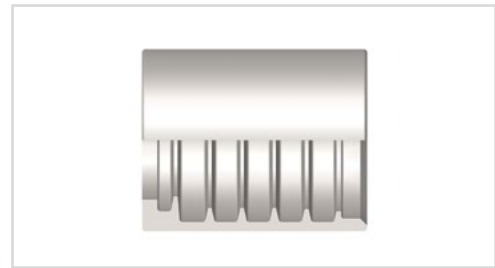

1 SC - EN 857 - ISO 11237-1 1SC (1 Wire Compact Non Skive Hose) no skive

DN	Größe Size	ø-innen ø-inside "	D mm	d mm	di mm	L mm	Bezeichnung Description	Artikel-Nr. Article no.
6		1/4"	21	13	13,5	30,6	PF 17 DN06	221730
8		5/16"	23,5	14,8	15,5	30,6	PF 17 DN08	221733
10		3/8"	24	16,1	16,5	33,5	PF 17 DN10	221418
12		1/2"	29	20	21	34,7	PF 17 DN12	221735
16		5/8"	32,5	23,3	24,7	36,8	PF 17 DN16	221419
20		3/4"	36,5	26	27,5	42,2	PF 17 DN20	221736
25		1"	45,5	32,7	35,5	50	PF 17 DN25	221737

2 SC - EN 853 - SAE 100 R17/R19 (2 Wire Compact Non Skive Hose) no skive

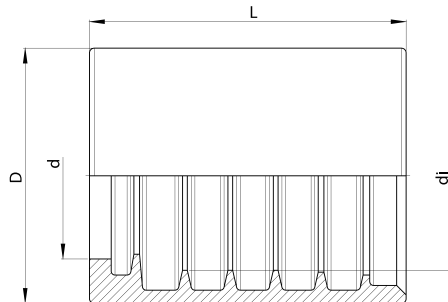
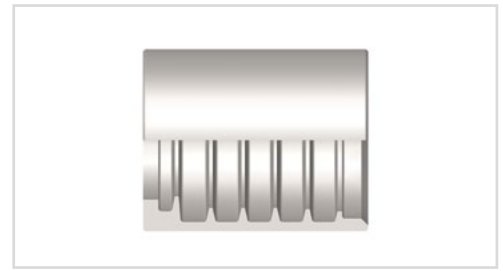

2 SC - EN 853 - SAE 100 R17/R19 (2 Wire Compact Non Skive Hose) no skive

DN	Größe Size	ø-innen ø-inside "	D mm	d mm	di mm	L mm	Bezeichnung Description	Artikel-Nr. Article no.
6		1/4"	23	13,2	16	30,6	PF 3 DN06	200747
8		5/16"	24	13,8	17,8	30,6	PF 3 DN08	200748
10		3/8"	27	17,6	20	33,5	PF 3 DN10	200749
12		1/2"	30	20,3	23,4	34,7	PF 3 DN12	200750
16		5/8"	34	23,3	26,7	36,8	PF 3 DN16	200752
20		3/4"	38	27,4	30,5	42,2	PF 3 DN20	200753
25		1"	48	34,4	39,3	48,3	PF 3 DN25	200754

**R 7 - EN 855 - SAE R7
(R7 Thermoplast Hose)
no skive**

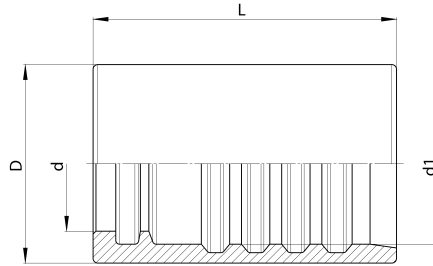
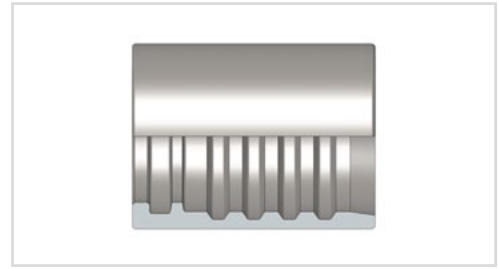

R 7 - EN 855 - SAE R7 (R7 Thermoplast Hose) no skive

DN	Größe Size	ø-innen ø-inside "	D mm	d mm	di mm	L mm	Bezeichnung Description	Artikel-Nr. Article no.
5	3/16"	3/16"	14,3	8,7	11,1	27,6	PF 8 DN05	200795
6	1/4"	1/4"	16,5	11,1	13,1	30,5	PF 8 DN06	200796
8	5/16"	5/16"	20	12,8	16	30,4	PF 8 DN08	200797
10	3/8"	3/8"	21	14,25	17	32,1	PF 8 DN10	200798
12	1/2"	1/2"	25,9	18,5	21,1	34,1	PF 8 DN12	209679
16	5/8"	5/8"	30	21,9	25	36,9	PF 8 DN16	209680
20	3/4"	3/4"	34,9	24,6	30,2	42,7	PF 8 DN20	209681
25	1"	1"	41,2	30,5	35,8	50,7	PF 8 DN25	209682

T1 Teflonschlauch (Smooth Bore PTFE Hose) no skive

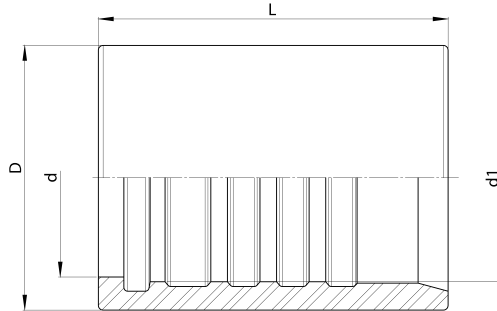
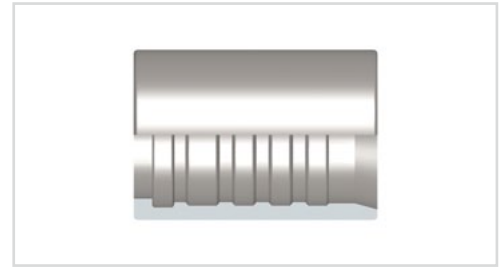

T1 Teflonschlauch (Smooth Bore PTFE Hose) no skive

DN	Größe Size	ø-innen ID	D mm	d mm	di mm	L mm	Bezeichnung Description	Artikel-Nr. Article No.
5		3/16"	14	9,1	9,8	26,2	PF 7 DN05	200787
6		1/4"	16	10,5	10,8	29,5	PF 7 DN06	200788
8		5/16"	18,5	12,5	13,3	29,5	PF 7 DN08	200789
10		3/8"	20	14,5	15,3	32	PF 7 DN10	200790
12		1/2"	24	18	19,3	34,5	PF 7 DN12	200791
16		5/8"	28	21	22,3	37	PF 7 DN16	200792
20		3/4"	31	24	25,8	42,5	PF 7 DN20	200793
25		1"	38	30,5	32,3	51	PF 7 DN25	200794

**W1 Teflon-Wellschlauch
(Convolute PTFE Hose)
no skive**

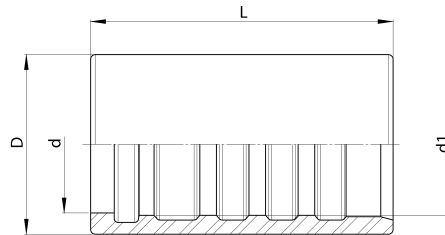
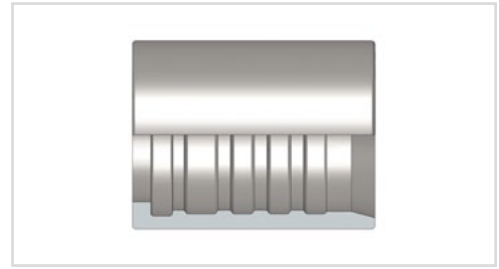

W1 Teflon-Wellschlauch (Convolute PTFE Hose) no skive

DN	Größe Size	ø-innen ID	D mm	d mm	di mm	L mm	Bezeichnung Description	Artikel-Nr. Article No.
6	1/4"		16	11,2	11,3	29,5	PF 9 DN06	200812
10	3/8"		19	14,5	15,3	32	PF 9 DN10	200813
12	1/2"		26,7	19	21,7	34,5	PF 9 DN12	200814
16	5/8"		29,5	22,5	24,8	37	PF 9 DN16	200815
20	3/4"		33	26	27,8	42,5	PF 9 DN20	200021
25	1"		40	33	35,3	51	PF 9 DN25	200802
32	1.1/4"		47	39	42,8	59	PF 9 DN32	200816
40	1.1/2"		58	48,5	51,3	62,5	PF 9 DN40	208168
50	2"		70	61,2	63,8	77,5	PF 9 DN50	208169

4 SP - EN 856 - SAE 100 R9R (4SP Multispiral Hose) skive1

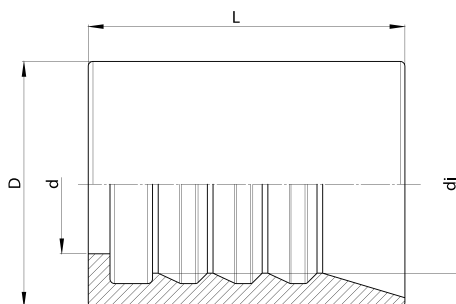
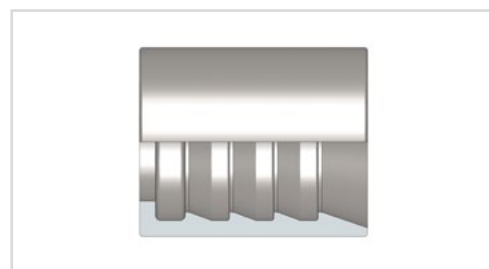

4 SP - EN 856 - SAE 100 R9R (4SP Multispiral Hose) skive1

DN	Größe Size	ø-innen ID	D mm	d mm	di mm	L mm	Bezeichnung Description	Artikel-Nr. Article No.
6	1/4"	1/4"	23,8	11,2	16	30,5	PF 5 DN06	200772
10	3/8"	3/8"	26	14,7	18,8	33,5	PF 5 DN10	200773
12	1/2"	1/2"	29,7	18,6	22,1	36	PF 5 DN12	200774
16	5/8"	5/8"	34,9	21,9	26,2	37	PF 5 DN16	200775
20	3/4"	3/4"	36,8	24,8	29,4	43	PF 5 DN20	200776
25	1"	1"	46	30,6	36,2	50,5	PF 5 DN25	200777
32	1.1/4"	1.1/4"	57,2	38,9	47,7	60	PF 5 DN32	200778
40	1.1/2"	1.1/2"	63,5	45,1	54	62,5	PF 5 DN40	200779
50	2"	2"	77,8	57,9	67,5	79	PF 5 DN50	200780

4 SH - EN 856
(4SH Multispiral Hose)
skive2

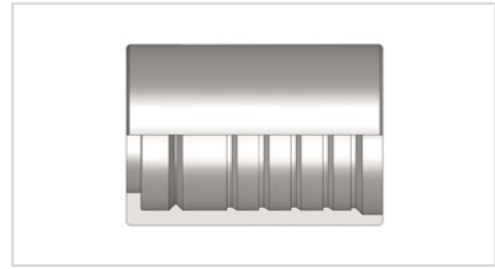

Interlock

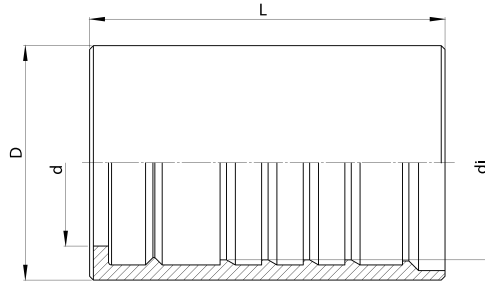

4 SH - EN 856 (4SH Multispiral Hose) skive2

DN	Größe Size	ø-innen ID	D mm	d mm	di mm	L mm	Bezeichnung Description	Artikel-Nr. Article No.
20	3/4"		39	25	31,5	60	PFI 4SH DN20	114471
25	1"		47	30,6	38,7	75	PFI 4SH DN25	114472
32	1.1/4"		55	37,7	44,2	88	PFI 4SH DN32	114463
40	1.1/2"		62	44	51,3	94	PFI 4SH DN40	114464
50	2"		78	57	66	99	PFI 4SH DN50	114465

R 13 - EN 856 - SAE 100 R13 (R13 Multispiral Hose) skive2

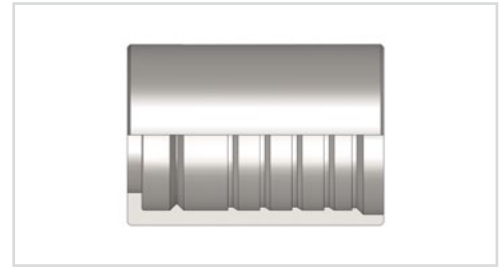

Interlock

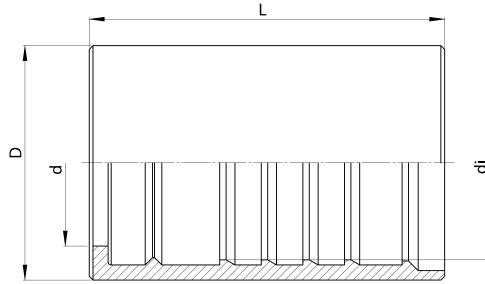

R 13 - EN 856 - SAE 100 R13 (R13 Multispiral Hose) skive2

DN	Größe Size	ø-innen ID	D mm	d mm	di mm	L mm	Bezeichnung Description	Artikel-Nr. Article No.
20	3/4"	3/4"	39	25	31,5	60	PFI R13 DN20	114471
25	1"	1"	47	30,6	38,7	75	PFI R13 DN25	114472
32	1.1/4"	1.1/4"	62	39,5	49,5	88	PFI R13 DN32	114469
40	1.1/2"	1.1/2"	69,5	46	56	94	PFI R13 DN40	114470
50	2"	2"	84,5	57,5	71	99	PFI R13 DN50	114473

**SAE 100 R15
(R15 Multispiral Hose)
skive2**

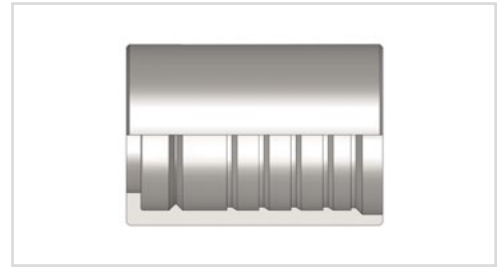

Interlock

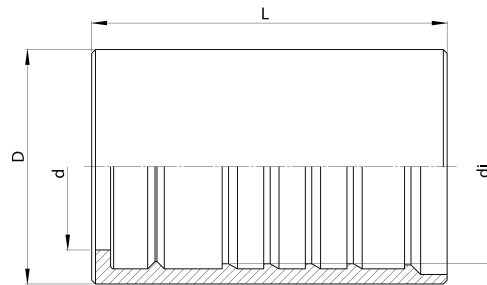

SAE 100 R15 (R15 Multispiral Hose) skive2

DN	Größe Size	ø-innen ID	D mm	d mm	di mm	L mm	Bezeichnung Description	Artikel-Nr. Article No.
20	3/4"		39	25	31,5	60	PFI R15 DN20	114471
25	1"		47	30,6	38,7	75	PFI R15 DN25	114472
32	1.1/4"		62	39,5	49,5	88	PFI R15 DN32	114469
40	1.1/2"		69,5	46	56	94	PFI R15 DN40	114470

Index Index

Bezeichnung Name	Kapitel Chapter	Seite Page
1 SC - EN 857 - ISO 11237-1 1SC (1 Wire Compact Non Skive Hose)	Pressfassungen / Ferrules	94
1 SN - EN 853 - SAE 100 R1AT (1 Wire Non Skive Hose)	Pressfassungen / Ferrules	92
1 ST - EN 853 - SAE 100 R1A (1 Wire Skive Hose)	Pressfassungen / Ferrules	90
2 SC - EN 853 - SAE 100 R17/R19 (2 Wire Compact Non Skive Hose)	Pressfassungen / Ferrules	95
2 SN - EN 853 - SAE 100 R2AT (2 Wire Non Skive Hose)	Pressfassungen / Ferrules	93
2 ST - EN 853 - SAE 100 R2A (2 Wire Skive Hose)	Pressfassungen / Ferrules	91
2 TE - EN 854 (1 Fabric Braid Hose)	Pressfassungen / Ferrules	88
3 TE - EN 854 (2 Fabric Braid Hose)	Pressfassungen / Ferrules	89
4 SH - EN 856 (4SH Multispiral Hose)	Pressfassungen / Ferrules	100
4 SP - EN 856 - SAE 100 R9R (4SP Multispiral Hose)	Pressfassungen / Ferrules	99
AGJ (JIC)	Schlaucharmaturen / Hose Fittings	55
AGN (NPT)	Schlaucharmaturen / Hose Fittings	63
AGR (BSPP)	Schlaucharmaturen / Hose Fittings	60
AGR - IN (BSPP Interlock)	Schlaucharmaturen - IN / Hose Fittings Interlock	80
AGR 45° - IN (BSPP Interlock 45°)	Schlaucharmaturen - IN / Hose Fittings Interlock	81
AGR 90° - IN (BSPP Interlock 90°)	Schlaucharmaturen - IN / Hose Fittings Interlock	82
AGR BSPT-m (BSPT Male)	Schlaucharmaturen / Hose Fittings	62
AGR WD (BSPP WD)	Schlaucharmaturen / Hose Fittings	61
BE (Metric Standpipe)	Schlaucharmaturen / Hose Fittings	47
BE 45° (Metric Standpipe 45°)	Schlaucharmaturen / Hose Fittings	48
BE 90° (Metric Standpipe 90°)	Schlaucharmaturen / Hose Fittings	49
CE (Metric Male)	Schlaucharmaturen / Hose Fittings	59
DKJ (JIC Female)	Schlaucharmaturen / Hose Fittings	56
DKJ 45° (JIC Female 45°)	Schlaucharmaturen / Hose Fittings	57
DKJ 90° (JIC Female 90°)	Schlaucharmaturen / Hose Fittings	58
DKLL / DKL / DKS	Schlaucharmaturen / Hose Fittings	44
DKLL / DKL / DKS 45°	Schlaucharmaturen / Hose Fittings	45
DKLL / DKL / DKS 90°	Schlaucharmaturen / Hose Fittings	46
DKO	Schlaucharmaturen / Hose Fittings	41
DKO - IN (DKO Interlock)	Schlaucharmaturen - IN / Hose Fittings Interlock	74
DKO 45°	Schlaucharmaturen / Hose Fittings	42
DKO 45° - IN (DKO Interlock 45°)	Schlaucharmaturen - IN / Hose Fittings Interlock	75
DKO 90°	Schlaucharmaturen / Hose Fittings	43
DKO 90° - IN (DKO Interlock 90°)	Schlaucharmaturen - IN / Hose Fittings Interlock	76
DKO KÄ (Water Blaster)	Schlaucharmaturen / Hose Fittings	70
DKR (BSPP Female)	Schlaucharmaturen / Hose Fittings	50
DKR - IN (BSPP Female Interlock)	Schlaucharmaturen - IN / Hose Fittings Interlock	77
DKR 45° (BSPP Female 45°)	Schlaucharmaturen / Hose Fittings	51
DKR 45° - IN (BSPP Female Interlock 45°)	Schlaucharmaturen - IN / Hose Fittings Interlock	78
DKR 90° (BSPP Female 90°)	Schlaucharmaturen / Hose Fittings	52
DKR 90° - IN (BSPP Female Interlock 90°)	Schlaucharmaturen - IN / Hose Fittings Interlock	79
DKRF (BSPP Female Flat Seal)	Schlaucharmaturen / Hose Fittings	53
DKRF 90° (BSPP Female Flat Seal 90°)	Schlaucharmaturen / Hose Fittings	54
DSN (Hose Connector)	Schlaucharmaturen / Hose Fittings	64
HSCH (Banjo Bolt)	Schlaucharmaturen / Hose Fittings	69
R 7 - EN 855 - SAE R7 (R7 Thermoplast Hose)	Pressfassungen / Ferrules	96
R 13 - EN 856 - SAE 100 R13 (R13 Multispiral Hose)	Pressfassungen / Ferrules	101
RGN (Banjo Hosetail)	Schlaucharmaturen / Hose Fittings	68
SAE 100 R15 (R15 Multispiral Hose)	Pressfassungen / Ferrules	102
SFL3 / SFS6 (Code 61 / 62)	Schlaucharmaturen / Hose Fittings	65
SFL3 / SFS6 - IN (Code 61 / 62 Interlock)	Schlaucharmaturen - IN / Hose Fittings Interlock	83
SFL3 / SFS6 45° (Code 61 / 62 45°)	Schlaucharmaturen / Hose Fittings	66
SFL3 / SFS6 45° - IN (Code 61 / 62 Interlock 45°)	Schlaucharmaturen - IN / Hose Fittings Interlock	84
SFL3 / SFS6 90° (Code 61 / 62 90°)	Schlaucharmaturen / Hose Fittings	67
SFL3 / SFS6 90° - IN (Code 61 / 62 Interlock 90°)	Schlaucharmaturen - IN / Hose Fittings Interlock	85
T1 Teflonschlauch (Smooth Bore PTFE Hose)	Pressfassungen / Ferrules	97
W1 Teflon-Wellschlauch (Convuluted PTFE Hose)	Pressfassungen / Ferrules	98

Volz Gruppe GmbH

Gartenstraße 6
78586 Deilingen (Germany)

T +49 7426 939-550

F +49 7426 939-555

www.volz.de | info@volz.de

Verschraubungen

Connectors

Adapter
Adapter

Schlaucharmaturen
Hose Fittings



Australia

Volz Australia Pty. Ltd.
Albury
T +61 260 236433
F +61 260 236431

Perth

T +61 8 9418-7239
F +61 8 9418-4167

China

Volz China Representative Office Shanghai
T +86 21 58358161
F +86 21 58352732

Russia

Volz RUS LLC
Sankt Petersburg
T +7 812 309-7555
F +7 812 309-7555

Singapore

Volz Asia Pte. Ltd.
Singapore
T +65 9321 8198
F +65 6862 4595

Turkey

Volz Hidrolik Pnömatik
Müh. Ltd. Sti.
Pendik-Dörtyol
Istanbul
T +90 216 5072307
F +90 216 3797943

Ukraine

Volz Ukraine LLC
Sumy
T +38 0542 663891
F +38 0542 663892

USA

Volz USA Inc.
Houston
T +1 281 60500151
F +1 281 6050015